

Professional Video Solutions

6MP Moonlight • VMS • Dual Thermal • IP Access Control • Analytics





Welcome	4	Software	44
MOBOTIX Milestones	4	MxManagementCenter	44
MOBOTIX Technology	6	MOBOTIX App	50
Product Selection Guide	8	MxActivitySensor	52
		MxAnalytics	54
Dual-Lens and Thermal Cameras	10	System Accessories	56
M15 AllroundDual Camera	10	Weatherproof Interface Boxes	56
M15-Thermal Camera	12	ExtIO Module	58
S15 FlexMount Camera	14	NPA-PoE Set	59
D15 DualDome Camera	16	Mx2wire+ Media Converter	60
V15 Vandalism Camera	18	S15 Mounts	62
		Optics	64
Single-Lens Cameras	20	Sensor Modules & Lens Units	64
c25 Hemispheric Camera	20	Lens Table	66
i25 Hemispheric Camera	22	Lens Selection Guide	68
p25 Hemispheric Camera	24		
v25 Vandalism Camera	26	The MOBOTIX Concept	70
Q25 Hemispheric Camera	28	Decentralized System	70
D25 Dome Camera	30	Hemispheric Technology	71
M25 Allround Camera	32	Superior Image Quality	72
S15M FlexMount Camera	34	Cost Benefits in Every Way	74
		Innovations to Differentiate	75
Hemispheric IP Video Door Station	36	Additional Information	76
Introduction	36	Glossary	76
Door Station Modules	38	References	78
MOBOTIX Smart Home	40		
MxDisplay+	42		

MOBOTIX 6MP Moonlight Sensor Technology

MOBOTIX 6MP cameras offer maximum light sensitivity and deliver highly detailed images with significantly reduced motion blurring even under the most difficult light conditions.

Made in Germany



Thanks to the highest manufacturing standards, MOBOTIX cameras are continuing to satisfy the requirements of the most demanding installations by delivering an exceptionally long product life and the utmost in reliability and security (see «References» on page 78).



1999
→

MOBOTIX Founded in June
Development of the Decentralized Concept

The MOBOTIX concept has completely changed the architecture of IP video. The camera is an all-in-one device, realizing a complete surveillance system.



2000
→

First Intelligent IP Camera at CeBIT
All Intelligence Inside

First CMOS based IP camera, without auto iris, with telephone modem, pioneering PoE and automatic event and long term recording using standard IT storage.



2001
→

First Dual Camera System
Dual Day Night Camera M1

World first dual camera with automatic switching between day and night sensor without any moving mechanical parts.



2002
→

MOBOTIX Ring Buffer Concept
First Feature to Bridge Network Failures

World first recording management to synchronize internal (RAM, SD Card) and external (NAS) ring buffer by the camera.



2004
→

MxPEG Perfect for Security
First Quality Video Codec

MxPEG was developed to achieve the best image quality at every single frame and is still today the only preferred video codec for security applications.



2005
→

SIP Compliant and Audio Worldwide
Available in All Cameras

Every camera is VoIP compliant based on worldwide SIP standard including video, featuring camera control, two way audio and automatic alarm calls.



2008
→

World First Hemispheric
IP Camera Q22

Introducing hemispheric technology has revolutionized IP video with real 180° panorama and the best corrected image quality in the market.



2010
→

First IP Video Door Station
Hemispheric T24 Camera Module

With the first IP Video Door Station, MOBOTIX has started to combine video surveillance with IP based entrance control.



2012
→

MOBOTIX Analytics Inside
Q24 Hemispheric

With 2nd generation of hemispheric products, MOBOTIX has provided object counting and heatmap reporting as free update inside the camera.



2013
→

MxActivitySensor
Game Changer in Motion Detection

MxActivitySensor has revolutionized motion detection in video surveillance with highest success rate to avoid false alarms at lowest configuration costs.



2014
→

World First Combination
of Thermal, Video and Motion Detection

MOBOTIX introduced the most innovative dual camera system, embracing thermal, video and MxActivity Sensor in one device to capture events in absolute darkness.



2015
→

MOBOTIX 6MP Moonlight Technology
Best Light Sensitivity in the Industry

New groundbreaking technology perfect for color images without any motion blurring in dark room or outdoor moonlight scenarios.

⁴ With 2nd generation of hemispheric products, MOBOTIX has provided object counting and heatmap reporting as free update inside the camera.



Decentralized Video – Stand Alone, Intelligence Inside

MOBOTIX is the pioneer of decentralized IP video systems, creating the first IP cameras that do not require any central PC (DVR). This decentralized in-camera intelligence allows users to build cost-effective systems that can be easily used for automatic video recording. The customer has the choice between onboard devices (SD card) or standard IT storage – No extra PC or software, no DVRs or VMS is required (see page 70).



Lowest Energy Bill – Green IP Video

All MOBOTIX cameras are supplied via standard PoE (IEEE 802.3af) and do not require more than 4 to 5 watts. This low power consumption is achieved because of the MOBOTIX low power design and assures one of the lowest energy bills in the market. Further energy savings are realized with lowlight (Moonlight) and thermal technologies, enabling our cameras to capture high-quality video without extra lighting equipment.

Software 100% Included

Every MOBOTIX camera comes with all the software necessary to create a high-quality surveillance system. Advanced functions are built into the camera, such as video management, image analysis, and VoIP calling. Professional Video Management System (VMS) is included for Windows and Mac without limits and costs (see pages 44-18).

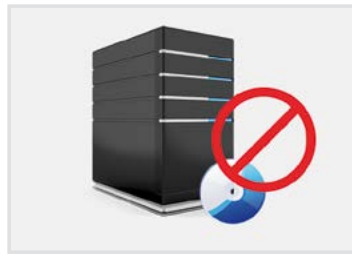

Ring Buffer Concept and Failover Storage

MOBOTIX invented in 2000 the ring-buffer concept to support long term onboard (SD card) or NAS recording to bridge network failures or bandwidth fluctuations. With MxFFS (MOBOTIX Flash File System), MOBOTIX cameras are able to bridge recordings and to use the built-in SD card as failover buffer in the case of connection loss to the external NAS. In addition, all cameras can use an external NAS as automatic backup to realize a safe, robust and efficient video recording system.

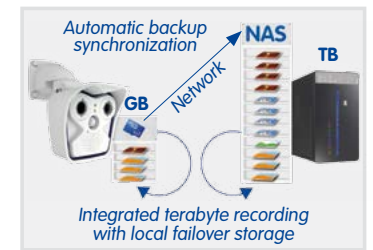

Moonlight Technology – A New Benchmark

All new MOBOTIX cameras are equipped with the brand-new 6MP Moonlight Technology, which gives an outstanding increase of light sensitivity of up to 300-times versus former models. The new 6MP technology is a major improvement of the whole image processing inside the camera, from the lens and sensor to the final image. This allows fast-moving objects to be captured in low light conditions like moonlight (see page 73).



Maintenance Free

Every MOBOTIX camera is a solid investment, built to withstand extreme weather conditions and temperatures for a very long time without moving parts. No additional housings or climate control systems are needed for outdoor installation. The fiber-glass reinforced outer housing protects the camera and is immune to corrosion and direct sunlight.

Innovative Motion Detection without False Alarms

MOBOTIX cameras include sophisticated sensor technologies to define precise events with the right notification activities. MxActivity-Sensor is able to detect motion during the most extreme conditions, without false alarms and complicated configuration, but with the highest reliability. MxActivitySensor reduces false alarms of up to 90 % and will save installation and operational costs dramatically (see page 52).



Privacy and Data Security

Every MOBOTIX system includes sophisticated password security with supervisory protection for users and cameras. Layered with our fully encrypted two-wire MxBus connectivity system and power backup, MOBOTIX offers unrivaled system privacy and data security. Recordings are encrypted to guarantee the security of the data.





Outdoor						
Dual Lens			Single Lens			
M15 (p. 10)	S15 (p. 14)	D15 (p. 16)	M25 (p. 32)	S15M (p. 34)	Q25 (p. 28)	D25 (p. 30)
Wall Mount Ceiling Mount	SurroundMount	Wall-/Pole Mount Set	Wall Mount Ceiling Mount	AudioMount	On-Wall	On-Wall
Pole Mount	HaloMount	Wall Mount	Pole Mount		Wall-/Pole Mount Set	Wall-/Pole Mount Set
	DualMount				Wall Mount	Wall Mount
	PTMount				Pole Mount	Pole Mount
	SpeakerMount				In-Ceiling	In-Ceiling
	BlockFlexMount				Demo Stand/ Wall Mount	Demo Stand/ Wall Mount

Indoor			Thermal	Building Automation		
Wall	Ceiling	PT Ceiling	Dual Lens		Camera	Remote Station
i25 (p. 22)	c25 (p. 20)	p25 (p. 24)	M15 (p. 12)	S15 (p. 14)	T25 (p. 36)	MxDisplay+ (p. 42)
On-Wall Set	On-Wall Set	On-Wall Set	Wall Mount Ceiling Mount	PTMount Thermal	FlatMountFrame	FlatMountFrame
In-Wall Set	Corner Mount		Pole Mount		In-Wall/On-Wall Single Frame	
					In-Wall/On-Wall Double Frame	
					In-Wall/On-Wall Triple Frame	
					In-Wall/On-Wall Quad Frame	
	Vandalism Camera					





Robust. Most Advanced Design.

The M15 features two light-sensitive image sensors and two lenses that allow the camera to generate sharp color videos and high-contrast B&W videos, even in dark situations. The electronic switching between the day and night system is automatic, with no moving parts and is based on light conditions to ensure reliable operation at any temperature and in any weather.

Intelligent Dual-Lens Surveillance

Along with an integrated microphone, speaker and sensor to record the ambient temperature, the weatherproof housing (IP66) features automatic recording onto SD cards and secure video motion analysis (MxActivitySensor) with alarm messaging.



Fast, Cost-Effective Installation

The M15 ships as a complete kit, including combined wall & ceiling mounts and other mounting accessories. As with all MOBOTIX cameras, no additional software, housings or cooling/heating fans are required.



Robust Design

By design, the M15 is the most robust of the entire MOBOTIX range of products. With an IP66 weatherproof rating, it can withstand extreme temperatures and the harshest of conditions.



Fully Integrated Future-proof System

The all-in-one sensor modules can be swapped out within minutes, thanks to our new modular hardware platform. The integrated locking system ensures the sensor modules remain fixed in place.

Technical Data			
Lens Options	B016 to B500	Min. Light Sensitivity	Day Sensor: 0.1 lux at 1/60 sec Night Sensor: 0.02 lux at 1/60 sec
Image Sensors	1/1.8" CMOS (6MP) Day (Color) or Night (B&W)	Sensor Resolution	6MP: 3072x2048 pixels (Color/B&W)
Max. Frame Rate (MxPEG)	MEGA/HD: 30 fps, QXGA: 15 fps, 6MP: 8 fps, 2x 6MP: 4 fps	Compression	MxPEG, M-JPEG, JPEG, H.264 (SIP video)
DVR Recording	Internal: microSD Card External: PC/NAS (to 4 TB)	Audio	Integrated microphone & speaker, VoIP, intercom, sound recording
Operating Conditions	IP66, IK07, -30 to +60 °C	Internal Sensors	Temperature, PIR, microphone illumination, shock detector
Image Processing	MxActivitySensor, VMD, image correction, backlight	Software (free of charge)	MxManagementCenter, MOBOTIX App

M15 – Reliable Even Under Extreme Conditions

The M15 camera is certified according to IP66 and has been successfully tested in a temperature range of -30 to +60 °C. In line with the proven MOBOTIX product strategy, the M15 model does not require additional cooling, heating or a special housing, and needs only five watts to be fully operational.

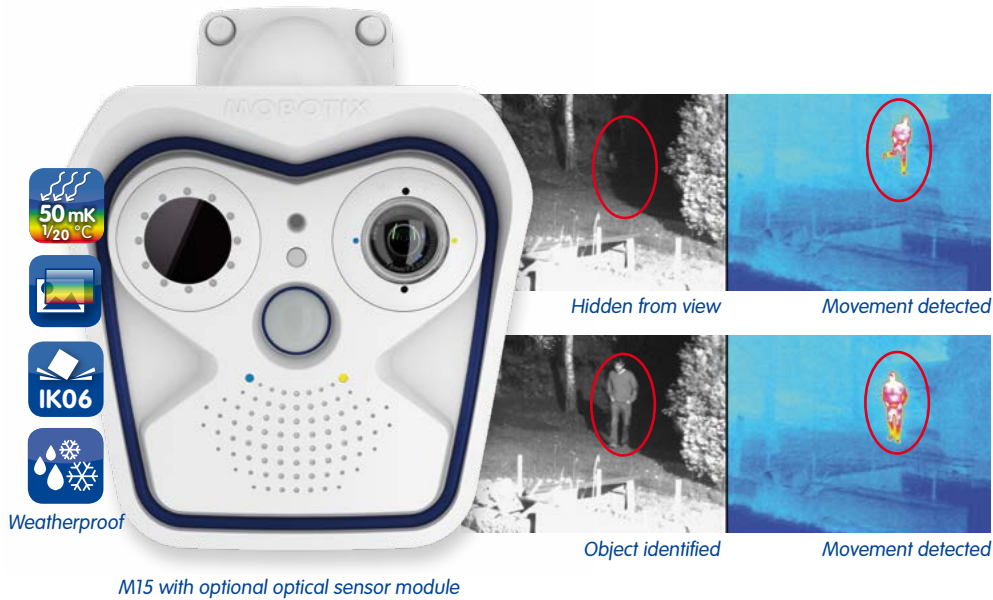

Thermal. Dual-Lens Camera. Detect and Identify.

The M15-Thermal is equipped with a pre-installed thermal image sensor that detects vehicles and people in total darkness with extremely high accuracy. A second optical sensor module can be fitted to provide positive object identification for complete lowlight security. Automatic temperature alarms can be generated automatically with thermal radiometry (TR), which is vital to detect potential fire or heat sources. MOBOTIX thermal dual camera systems offer also thermal overlay to localize hot spots in the visual image to prevent bigger damages and fire.

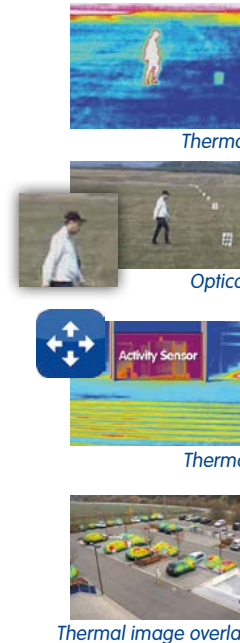

Thermal: Detect Movement around the Clock

High thermal resolution allows moving object detection up to 400 m in total darkness and in all conditions such as smoke, dust, fog. No lighting required.

Optical: Identify Objects

The M15-Thermal dual-lens design allows for a secondary optical lens to be fitted for clear identification of facial features, clothing, license plate numbers, vehicle color etc.

Privacy Zone – Identification and Recognition on Event

Combined with **MxActivitySensor**, the camera automatically switches from thermal sensor to optical sensor, when an object moves into the pre-defined privacy zone. This ensures the identification and recognition of moving objects only when MxActivitySensor triggers an alarm.

Thermal Overlay

Hotspots can be visualized very fast by overlaying the thermal image on the optical image which helps to identify dangerous heat or fire sources. This technology can be used very efficiently in fire protection to localize potential origins of danger.

Technical Data			
Lens Options	Thermal: L43, L65, L135 (factory-fitted, not interchangeable) Optical: B016 to B500	Min. Light Sensitivity	Day Sensor: 0.1 lux at 1/60 sec Night Sensor: 0.02 lux at 1/60 sec Thermal Sensor: 0 lux
Optical Image Sensor	1/1.8" CMOS (6MP) Day (Color) or Night (B&W)	Optical Sensor Resolution	6MP: 3072x2048 pixels (Color/B&W)
Thermal Image Sensor	Uncooled microbolometer temp. measuring range from -40 to +550 °C	Thermal Sensor Resolution	Thermal: 336x252 NETD typically 50 mK (1/20 °C) MTBF > 80,000 hours
Max. Frame Rate (MxPEG)	Thermal only: max. 9 fps Thermal and optical: 9 fps Optical only: 30 fps	Compression	MxPEG, M-JPEG, JPEG, H.264 (SIP video only)
DVR Recording	Internal: microSD Card External: PC/NAS (to 4 TB)	Audio	Integrated microphone & speaker, VoIP, intercom, sound recording
Operating Conditions	IP66, IK06, -30 to +60 °C	Internal Sensors	Temperature, PIR, microphone illumination, shock detector
Image Processing	MxActivitySensor, VMD, image correction, backlight	Software (free of charge)	MxManagementCenter, MOBOTIX App

M15-Thermal – Weatherproof Thermographic PoE Dual Camera

The modular design of the M15 platform provides the ultimate in flexibility. The M15-Thermal is factory-fitted with a thermal image sensor for accurate movement detection over long distances in all lighting conditions. An additional (optional) image sensor is used to identify people and objects.

Movement Detection in All Conditions

The M15 and S15 thermal sensors detect objects in complete darkness and/or through fog and smoke. Primarily designed for accurate movement detection over large areas such as border protection and coastal monitoring. The M15-Thermal camera has a super low power consumption – max. 5.5 W.



Optical sensor modules
see page 64



Weatherproof

Indoors and outdoors

Flexible. Virtually Invisible Dual-Lens Camera.

With its unique fusion of dual sensor technology and flexmount design, the S15 covers two areas at once and is virtually invisible. The S15 has been perfectly created for customized solutions or installations where standard cameras simply won't fit.



Flexible Installation

The S15 core unit miniature size fits into tight spaces (ATMs, machinery, vehicles). The flexible 3 m video cables make it a easy to create customized installations (see page 62).



Double Hemispheric = 360° Full Spherical Capture

This cost-effective solution can simultaneously capture and record two super-wide 360° fields of view, providing the same coverage as eight standard CCTV cameras.



White Black

Virtually Invisible

With a diameter of only 50 mm and available in both white and black, the S15 sensor modules blend in with any environment. Ideal for applications where standard-sized cameras are unsuitable.



Secure Two Areas with One Device

The two flexible video cables allow for coverage of two separate areas. Just one S15 can secure two separate rooms, an indoor and outdoor area and around corners.

Technical Data			
Lens Options	Optical: B016 to B500 Thermal: L43, L65, L135	Min. Light Sensitivity	Day Sensor: 0.1 lux at 1/60 sec Night Sensor: 0.02 lux at 1/60 sec Thermal Sensor: 0 lux
Image Sensors	1/1.8" CMOS (6MP) Day (Color) or Night (B&W)	Sensor Resolution	6MP: 3072x2048 pixels (Color/B&W)
Max. Frame Rate (MxPEG)	MEGA/HD: 30 fps, QXGA: 15 fps, 6MP: 8 fps, 2x 6MP: 4 fps, Thermal: 9 fps	Compression	MxPEG, M-JPEG, JPEG, H.264 (SIP video only)
DVR Recording	Internal: microSD Card External: PC/NAS (to 4 TB)	Audio	2-way VoIP available with accessories such as the SpeakerMount
Operating Conditions	IP65, IK06, -30 to +60 °C	Internal Sensors	Temperature, microphone, illumination, shock detector
Image Processing	MxActivitySensor, VMD, image correction, backlight	Software (free of charge)	MxManagementCenter, MOBOTIX App

Weatherproof Thermal Sensor Modules (L43, L65 and L135)



The S15 can also be operated with one or two thermal sensor modules. Objects can be detected in total darkness, smog or smoke thanks to thermal technology. The thermal sensor modules feature low power consumption of only 1.5 W each (NETD: typically 50 mK; MTBF: >80,000 hours; temperature measuring range: -40 to +550°C).

Manual PTMount with Integrated Thermal Sensor

MOBOTIX offers the weatherproof PTMount-Thermal (IP65), an attractive, compact, discreet and dome-shaped mount that is adjustable in three directions and contains a pre-installed MOBOTIX L43, L65 or L135 thermal sensor module. For additional information on the PTMount-Thermal see page 12.





Adjustable lens modules can capture two different areas simultaneously.

Versatile. Twice as Vigilant.

The D15 is a dual-sensor dome camera with two lens modules providing a wide range of fully adjustable viewing options for a huge variety of applications. The D15 is completely modular and can be setup as standard DualDome, as 180° model with super-wide panorama field of view or as day-night version.

D15 – Modular Fixdome with Two Lens Units

The D15 is able to secure two different areas simultaneously. The key advantage of the D15 is its manually adjustable lens configuration and the completely modular structure. Once installed, the lens units can be fixed into any position.



Adjustable lenses

Flexible Installation

The D15 is characterized by complete modularity. Choose from available lens carriers (pano, fix), lens units, all fully adjustable in any direction within the camera. This flexibility, combined with the dual-lens system, provides practically unlimited viewing options from one camera.



180°

Panoramic View

The D15 can be setup as 180° model with the panorama carrier and captures a super-wide view. D15 provides live and recorded images with a maximum resolution of 12 megapixels. PTZ and image settings can be easily tuned with the integrated camera features.



Fixed lenses

Day & Night Capture

The D15 body can be also equipped with a day&night carrier, which provides parallel alignment of two lenses for perfect same-view day and night video capture.

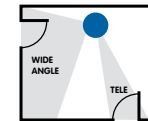

Two Cameras in One

Dual-lens system captures two different views simultaneously and requires only a single PoE cable connection.

Technical Data			
Lens Options	B036 to B237, 180° version (panorama), DNight-FIX version with parallel Day/Night lenses	Min. Light Sensitivity	Day Sensor: 0.1 lux at 1/60 sec Night Sensor: 0.02 lux at 1/60 sec
Image Sensors	1/1.8" CMOS (6MP) Day (Color) or Night (B&W)	Sensor Resolution	6MP: 3072x2048 pixels (Color/B&W)
Max. Frame Rate (MxPEG)	MEGA/HD: 30 fps, QXGA: 15 fps, 6MP: 8 fps, 2x 6MP: 4 fps	Compression	MxPEG, M-JPEG, JPEG, H.264 (SIP video only)
DVR Recording	Internal: microSD Card External: PC/NAS (to 4 TB)	Audio	Integrated microphone & speaker, VoIP, intercom, sound recording
Operating Conditions	IP65/54 (with/without wall mount), IK10, IP66/IK10+ (with Vandalism Kit), -30 to +60 °C	Internal Sensors	Temperature, PIR, microphone illumination, shock detector
Image Processing	MxActivitySensor, VMD, image correction, backlight	Software (free of charge)	MxManagementCenter, MOBOTIX App

D15 – Individual and Modular

The standard models of the D15 stand out in particular as they allow nearly any combination of image sensors and lenses. For a complete range of D15 lens units please refer to page 10.

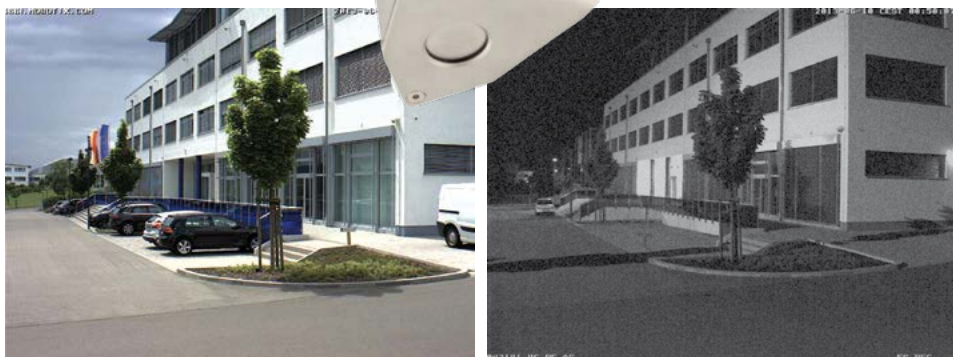

LEFT sensor

RIGHT sensor

High-Security Dual-Lens Camera.

Constructed from 5 mm stainless steel, the V15 is a bullet-resistant corner-mounted IP dual-lens camera designed for monitoring potentially volatile conditions. Made for high-security locations such as military sites, prisons and embassies or extreme environmental conditions.



With S15 Technology

Hidden inside the V15 is an S15 core unit and two sensor modules, so of course it includes the range of features and lens options available within the S15 (except Hemispheric). Includes 2-way audio thanks to integrated microphone and speaker.

Armor-Plating

The outer housing is designed for corner-mounting and is constructed from 5 mm stainless steel plating that will deflect bullets fired from a handgun.

Versatile Installation

The V15 comes in two models. One has a parallel alignment of two sensor modules for perfect same-view day and night video capture. The other model includes one lens facing forward, the second lens facing down to avoid blind spots.

Technical Data			
Lens Options	Sensor modules B036 to B237	Min. Light Sensitivity	Day Sensor: 0.1 lux at 1/60 sec Night Sensor: 0.02 lux at 1/60 sec
Image Sensors	1/1.8" CMOS (6MP) Day (Color) or Night (B&W)	Sensor Resolution	6MP: 3072x2048 pixels (Color/B&W)
Max. Frame Rate (MxPEG)	MEGA/HD: 30 fps, QXGA: 15 fps, 6MP: 8 fps, 2x 6MP: 4 fps	Compression	MxPEG, M-JPEG, JPEG, H.264 (SIP video only)
DVR Recording	Internal: microSD Card External: PC/NAS (to 4 TB)	Audio	Integrated microphone & speaker, VoIP, intercom, sound recording
Operating Conditions	IP65, bullet-proof, IK10++, -30 to +60 °C	Internal Sensors	Temperature, microphone illumination, shock detector
Image Processing	MxActivitySensor, VMD, image correction, backlight	Software (free of charge)	MxManagementCenter, MOBOTIX App
Lens Protection	3 mm special glas	Housing	5 mm stainless steel

V15 – Bullet-Resistant for High-Risk Installations

The V15 is the most sturdy MOBOTIX camera to-date. Specifically designed for high-risk areas, it offers unmatched protection against attacks. Nonetheless, it's still a camera with MOBOTIX technology and the full array of possibilities to connect external sensors and actuators.

V15 – Modularity Guarantees High ROI

Based on the modular S15 platform, the V15 allows using almost the same range of sensor modules (except for the Hemispheric modules). To see the range of V15 sensor module options, go to page 64.



The ceiling-mounted c25 delivers two 180° panorama images of a room.

Indoor Ceiling Camera. Easy to Install.

With a diameter of only 12 centimeters and a weight of approximately 200 grams, the c25 is the smallest and lightest hemispheric MOBOTIX video complete system for fast ceiling mounting in protected indoor areas. Features include a light-sensitive 6MP day or night sensor and MxAnalytics. Features all functions like the traditional Q25 outdoor camera.



Perfect Coverage

The c25 is available as hemispheric camera (B016, day or night version) installed in the ceiling for behavioral detection or equipped with the 103° ultra wide angle lens (B036) mounted in the corner to cover a complete room without any blind spots.



Perfect Overview without Blind Spots

The new corner solution c25-100 consists of the 6MP c25 indoor camera equipped with the 103° premium lens and the newly designed corner mount. This combination is perfect to create a discrete and appealing interior design solution to cover a complete room from wall to wall without any blind spots. The corner mount can be easily installed on 3 different fixation points, whereas the c25 will be installed in the mount without any tools thanks to the innovative click-in mechanism of MOBOTIX.

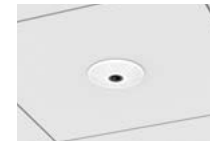

Simple Installation in Suspended Ceilings

The c25 can be easily installed using a standard drill bit (105 mm in diameter) in suspended ceilings. The c25, which is connected to an Ethernet cable, is simply slotted in from below using raised spring clips and automatically secured in place.



MxAnalytics with Behavioral Detection

Especially interesting for indoor applications like retail, exhibition area, public premises, the c25 provides object counting and automatic Heatmap reporting inside the camera. As a new extension, people behavior can be defined as event trigger, for example duration of stay, moving in the opposite direction, different turns and exceeding speed limits. MxAnalytics does not require any additional infrastructure or extra costs.

Technical Data			
Lens Options	B016, B036	Min. Light Sensitivity	Day Sensor: 0.1 lux at 1/60 sec Night Sensor: 0.02 lux at 1/60 sec
Image Sensors	1/1.8" CMOS (6MP) Day (Color) or Night (B&W)	Sensor Resolution	6MP: 3072x2048 pixels (Color/B&W)
Max. Frame Rate (MxPEG)	MEGA/HD: 30 fps, QXGA: 15 fps, 6MP: 8 fps	Compression	MxPEG, M-JPEG, JPEG, H.264 (SIP video only)
DVR Recording	Internal: microSD Card External: PC/NAS (to 4 TB)	Audio (optional)	VoIP, sound recording using audio package
Operating Conditions	IP20, 0 to +40 °C	Internal Sensors	Temperature, illumination, shock detector
Image Processing	MxActivitySensor, VMD, image correction, backlight, MxAnalytics	Software (free of charge)	MxManagementCenter, MOBOTIX App

Complete MOBOTIX Indoor Camera Line

With the c25, i25, p25 and v25, MOBOTIX offers a highly compact and discreet IP camera line for indoor usage which are equipped with all MOBOTIX functions (e. g. video analysis).



Wall-mounted i25 captures 180° field of view – no blind spots.

Perfect Wall Mount. Compact and Discrete.

The i25 is a 6MP hemispheric camera and is perfectly suited to be wall mounted with a tilt angle of 15 degree to achieve the best panoramic overview of a room without any blind spots. One i25 captures an entire room, easily replacing four standard cameras. The newly-designed wall mount form factor fits into every environment.



Lens tilted down 15 deg.

Perfect Fit

The i25 can be wall mounted onto any surface. The small form factor matches perfectly with any environment. For fast installations, simply use the optional cavity installation set. A surface mount kit for concrete walls, for example, is available as well.



Ideal for Wall Mounting

The i25 hemispheric model will be wall mounted with a tilt angle of 15 degree to achieve a perfect panoramic overview of a room. If mounted above the door, the i25 looks even partially underneath or into the door. A 103° model is available too.



HD Audio Package (optional)

All 6MP indoor models are available upon request with an integrated HD audio package (microphone and speaker in the camera housing). In addition to video recording with sound, the audio functionality can also be used for making announcements in sales or exhibition rooms, or for automatically playing an alarm signal when the camera-integrated sensor is triggered to scare off undesired visitors.

Technical Data

Lens Options	B016, B036	Min. Light Sensitivity	Day Sensor: 0.1 lux at 1/60 sec
Image Sensors	1/1.8" CMOS (6MP), Day (Color)	Sensor Resolution	6MP: 3072x2048 pixels (Color)
Max. Frame Rate (MxPEG)	MEGA/HD: 30 fps, QXGA: 15 fps, 6MP: 8 fps	Compression	MxPEG, M-JPEG, JPEG, H.264 (SIP video only)
DVR Recording	Internal: microSD Card External: PC/NAS (to 4 TB)	Audio (optional)	VoIP, sound recording using audio package
Operating Conditions	IP30, 0 to +40 °C	Internal Sensors	Temperature, illumination, shock detector
Image Processing	MxActivitySensor, VMD, image correction, backlight, MxAnalytics	Software (free of charge)	MxManagementCenter, MOBOTIX App

i25 – The Perfect Overview

The MOBOTIX i25 is an indoor-only wall-mountable Hemispheric camera providing an allround view with just one lens. Only one camera is needed to view an entire room. The i25 can be mounted onto any indoor surface blending seamlessly into the surroundings.

Accessory Options

The detachable MxBus-IO-Module is an extension of the system accessories for the indoor camera line. Connected to a MOBOTIX indoor camera, the module with 2 self-powered inputs and 2 outputs allows to access MxBus and the connection of external sensors or the switching of relays.





Even at difficult low light conditions (approx. 1.5 lux), c25 delivers perfect and detailed video (ceiling-mounted, panorama view).

The Perfect Ceiling Camera.

The new p25 6MP model is equipped with the brand-new 6MP Moonlight Sensor Technology, providing best low-light performance to cope with every indoor situation. The p25 is positioned extremely price competitive and represents with all included MOBOTIX features and the MOBOTIX video management system MxMC, one of the most attractive security solutions in the market.



Tilt angle with every lens $\pm 20^\circ$

Highest Flexibility

The new p25 is a ceiling camera with a manual pan/tilt functionality providing full installation flexibility. Equipped with a telephoto lens, the p25 can be directed to a specific spot in the room. With a 103 degree lens and mounted in the corner, the p25 covers the entire space in 6MP resolution. A hemispheric version and on-wall kit is available, too. Beside the pre-built models, nearly all lens options can be self-assembled with a p25 day or night body.

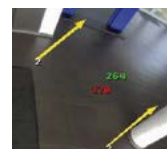

MxAnalytics

The p25 provides people counting and analysis of people behavior, without any extra costs, which is perfect for indoor locations like retail stores, museums, etc. Without any extra PC or license fees, the p25 represents highest flexibility and cost savings for end users.



Competitive without Compromise

Beside MxAnalytics, all other MOBOTIX features are included, such as MxActivitySensor – which avoids 95 % of false alarms – on board and/or NAS recording, notification via email, FTP and IP request, and much more.

Technical Data

Lens Options	B016	Min. Light Sensitivity	Day Sensor: 0.1 lux at 1/60 sec
Image Sensors	1/1.8" CMOS (6MP) Day (Color)	Sensor Resolution	6MP: 3072x2048 pixels (Color)
Max. Frame Rate (MxPEG)	MEGA/HD: 30 fps, QXGA: 15 fps, 6MP: 8 fps	Compression	MxPEG, M-JPEG, JPEG, H.264 (SIP video only)
DVR Recording	Internal: microSD Card External: PC/NAS (to 4 TB)	Audio (optional)	VoIP, sound recording using audio package
Operating Conditions	IP20, 0 to +40 °C	Internal Sensors	Temperature, illumination, shock detector
Image Processing	MxActivitySensor, VMD, image correction, backlight, MxAnalytics	Software (free of charge)	MxManagementCenter, MOBOTIX App

Audio Option and On-Wall Kit

For all indoor models (i25, c25, p25, v25), there will be a surface mount kit to cope with concrete ceilings, as well as an optional audio package incl. microphone and speaker, to enable two-way audio communication.



103° (B036)



60° (B061)



45° (B079)



31° (B119)

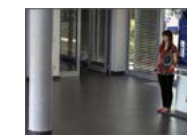

15° (B237)



6 MP
Sensor



IK10



Perfect Protection. Professional Functions.

The new v25 camera offers as the first MOBOTIX vandalism indoor camera all outstanding MOBOTIX features. In addition to the standard lens options there is an on-wall audio kit with the suitable vandalism sets.

Complete Protection

For the new v25 6MP model there will be two vandalism kits providing complete case protection of the v25, even with the optional on-wall audio kit.



v25 Body



v25 with On-Wall Audio Kit



All Inclusive

A complete standalone video surveillance system, including SD card or NAS event recording, alarming, professional video management (VMS) and video analysis functions like heat map and object statistics is available. The v25 body with MOBOTIX 6MP Moonlight day or night sensor technology is compatible with all standard lens options including the new 103° lens to cover a complete room without any blind spots.

Easy Installation

Like all 6MP indoor models (i25, c25 and p25), the v25 can also be easily installed within minutes. v25 supports all standard lenses to ensure always the perfect solution for any indoor environment. Installed either in ceiling- or wall mount positions, the v25 can be adjusted in both directions, horizontally and vertically providing always the ideal viewing angle.

Perfect Protection

The new v25 6MP model will be supported with two vandalism kits including a stainless steel protection ring and reinforced dome cover. The new vandalism kits provide complete case protection up to IK10 of the v25 either for the standard v25 or equipped with the additional on-wall audio kit.

Technical Data			
Lens Options	B036 to B237	Min. Light Sensitivity	Day Sensor: 0.1 lux at 1/60 sec Night Sensor: 0.02 lux at 1/60 sec
Image Sensors	1/1,8" CMOS (6MP) Day (Color) or Night (B&W)	Sensor Resolution	6MP: 3072x2048 pixels (Color/B&W)
Max. Frame Rate (MxPEG)	MEGA/HD: 30 B/s, QXGA: 15 B/s, 6MP: 8 B/s	Compression	MxPEG, M-JPEG, JPEG, H.264 (SIP video only)
DVR Recording	Internal: microSD Card External: PC/NAS (to 4 TB)	Audio (optional)	Sound recording using audio package
Operating Conditions	IP20, 0 to +40 °C, IK10 (with Vandalism kit)	Internal Sensors	Temperature, illumination, shock detector
Image Processing	MxActivitySensor, VMD, image correction, backlight, MxAnalytics	Software (free of charge)	MxManagementCenter, MOBOTIX App

Optional Accessories

v25 can be equipped with the on-wall audio kit to realize two-way HD audio incl. microphone and speaker. v25 is compatible to the new MxTubeMount to be installed in unstructured ceilings like in supermarkets, airports, etc.





Wall-mounted Q25 captures 180° field of view – no blind spots.

Elegant. Allround Secure.

Setting a new benchmark in design, this all-in-one Hemispheric camera offers a super-wide 360° allround view, in high resolution. Easily replacing four standard cameras, just one Q25 captures an entire room. The Q25 is highly discreet and fits in everywhere – both indoors and outdoors.



With Vandalism Kit



Weatherproof



Fits in Everywhere

The Q25 can be flush-mounted into a wall or ceiling, and looks more like a mounted speaker than a security camera. The low-profile form factor fits in with every environment (pictured with in-ceiling mount set).



Image Correction Built-in

All of the image correction in the MOBOTIX Hemispheric cameras is handled by the camera's on-board imaging analysis software. No additional PC or software required.



Day or Night Capture

Available in both Day (color) and Night (B&W) models, which cater to the most challenging lighting conditions and a wide range of applications.

Technical Data			
Lens Options	B016	Min. Light Sensitivity	Day Sensor: 0.1 lux at 1/60 sec Night Sensor: 0.02 lux at 1/60 sec
Image Sensors	1/1.8" CMOS (6MP) Day (Color) or Night (B&W)	Sensor Resolution	6MP: 3072x2048 pixels (Color/B&W)
Max. Frame Rate (MxPEG)	MEGA/HD: 30 fps, QXGA: 15 fps, 6MP: 8 fps	Compression	MxPEG, M-JPEG, JPEG, H.264 (SIP video only)
DVR Recording	Internal: microSD Card External: PC/NAS (to 4 TB)	Audio	Integrated microphone & speaker, VoIP, intercom, sound recording
Operating Conditions	IP65, IK07, IP66/IK10 (with Vandalism Kit), -30 to +50 °C	Internal Sensors	Temperature, microphone, illumination, shock detector.
Image Processing	MxActivitySensor, VMD, image correction, backlight, MxAnalytics	Software (free of charge)	MxManagementCenter, MOBOTIX App

Q25 – The Perfect Overview

The Q25 provides a Hemispheric 360° allround view with just one lens. Only one camera is needed to view an entire room. Using the in-ceiling mount option, the Q25 can be flush-mounted into a ceiling so that it blends elegantly into the surroundings.

MOBOTIX Panorama Image Technology

Unlike competitors, hemispheric distortion correction takes place in the MOBOTIX camera and not later on the computer. This drastically reduces the image data before it is transferred and saved. This "decentralized" MOBOTIX solution lowers the volume of network traffic and allows dozens of hemispheric cameras to be displayed on a computer or smartphone.

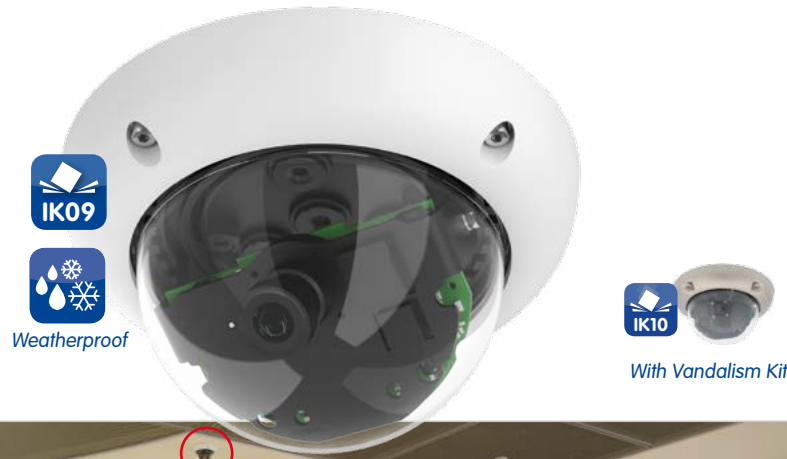

Traditional Design. Innovative Technology.

Bringing unprecedented technology and video performance to a traditional dome camera form factor. The MOBOTIX D25 offers the same advanced engineering and innovative technology of all the MOBOTIX cameras.

D25 – Compact, Cost-Efficient and with High Resolution

This weatherproof dome camera is the right choice for sites requiring a traditional dome form factor. The in-ceiling mount provides a low profile for discreet surveillance.



Traditional Yet Innovative

Beneath the traditional dome interior is a powerful VMS-enabled hardware platform with decentralized recording management and a 6MP image sensor for high-quality video capture.



In-Ceiling Mount

The in-ceiling mount kit allows the D25 to be mounted into a ceiling tile for a low-profile dome installation that blends into the surrounding environment.



Vandalism Set

Protect your camera investment with this tough vandalism set comprised of a high-tensile stainless steel outer ring and a 3 mm/0.1 in. polycarbonate dome. All vandalism sets have an IK10 impact rating.



Intercom Expansion

By combining the D25 with an ExtIO (see page 58), you can create a powerful 2-way intercom system that integrates seamlessly with your PC, Mac or iOS devices.

Technical Data			
Lens Options	B036 to B237	Min. Light Sensitivity	Day Sensor: 0.1 lux at 1/60 sec Night Sensor: 0.02 lux at 1/60 sec
Image Sensors	1/1.8" CMOS (6MP) Day (Color) or Night (B&W)	Sensor Resolution	6MP: 3072x2048 pixels (Color/B&W)
Max. Frame Rate (MxPEG)	MEGA/HD: 30 fps, QXGA: 15 fps, 6MP: 8 fps	Compression	MxPEG, M-JPEG, JPEG, H.264 (SIP video only)
DVR Recording	Internal: microSD Card External: PC/NAS (to 4 TB)	Audio (ExtIO required)	Integrated microphone & speaker, VoIP, intercom, sound recording via ExtIO
Operating Conditions	IP65/66 and IK09/10 (without/with vandalism kit), -30 to +50 °C	Internal Sensors	Temperature, illumination, shock detector
Image Processing	MxActivitySensor, VMD, image correction, backlight, MxAnalytics	Software (free of charge)	MxManagementCenter, MOBOTIX App

D25 – Well Designed

All D25 models come with a robust 1.5 mm/0.06 in. polycarbonate dome. An extensive range of mounting accessories is also available for expanding device functionality, so that the camera can be installed anywhere.



Camera image of Mount Everest, recorded by the highest webcam in the world (5675 m altitude).

Tough. For Any Environment.

Designed and engineered to withstand the most demanding of conditions, featuring high tolerance and an IP66 rating. The M25 features the 6MP technology and is highly adaptive as to where it can be deployed, thanks to the wide choice of available lenses.



Fast, Cost-Effective Installation

The M25 ships as a complete kit, including wall & ceiling mounts and other mounting accessories. As with all MOBOTIX cameras, no additional software, housings or cooling/heating fans required.



Tough Design

The M25 is built tough, with an IP66 weatherproof rating, it can withstand extreme temperatures and the harshest of conditions. The fibreglass re-inforced outer housing is designed for long life.



2-Way Audio

Like the other MOBOTIX cameras, the M25 has built-in VoIP functionality for 2-way lip synchronous audio/video via IP phones and mobile devices.



Powerful 270 mm Telephoto Capture

It is possible to identify license plates and people even at distances of more than 70 meters/230 ft. thanks to the B500 lens that can be used with the M25 and the high-resolution 6MP sensor.

Technical Data			
Lens Options	B016, B036 to B500	Min. Light Sensitivity	Day Sensor: 0.1 lux at 1/60 sec Night Sensor: 0.02 lux at 1/60 sec
Image Sensors	1/1.8" CMOS (6MP) Day (Color) or Night (B&W)	Sensor Resolution	6MP: 3072x2048 pixels (Color/B&W)
Max. Frame Rate (MxPEG)	MEGA/HD: 30 fps, QXGA: 15 fps, 6MP: 8 fps	Compression	MxPEG, M-JPEG, JPEG, H.264 (SIP video only)
DVR Recording	Internal: microSD Card External: PC/NAS (to 4 TB)	Audio	Integrated microphone & speaker, VoIP, intercom, sound recording
Operating Conditions	IP66, IK08, -30 to +50 °C	Internal Sensors	Temperature, microphone, illumination, shock detector
Image Processing	MxActivitySensor, VMD, image correction, backlight, MxAnalytics	Software (free of charge)	MxManagementCenter, MOBOTIX App

M25 – The Robust Allrounder

The cost-effective and professional single-lens camera solution with exchangeable lenses for indoor and outdoor use. The lenses can be freely selected: from Hemispheric through Super Wide Angle to Telephoto lens, CSVario adjustable lens and Long Pass Filter for license plate capture.

Lens Units with Long Pass Filters (LPF)

The Long Pass Filter (LPF) is part of a special black & white lens that, together with an infrared lamp, allows for optimal license plate recognition in all lighting conditions.



LPF



Weatherproof



The S15M is a single-lens hemispheric video device that mounts discreetly behind surface panels.

Sees Everything. Is Hard to See.

Never before has so much power and functionality been incorporated into such a tiny form factor. The camera features 6MP Hemispheric video technology for discreet integration into housings and devices, behind walls or ceiling panels.



Hemispheric Video

Capturing a super-wide 180° field of view, the S15M captures everything wall-to-wall. The Hemispheric image correction is handled by the camera, no additional software required.



Door Station

The optional AudioMount turns the S15M into an IP Video Door Station. The built-in speaker and microphone integrates with the S15 VoIP functionality, allowing 2-way communication.



Discreet

The compact design allows for installation into small spaces and cavities. When flush-mounted behind a wall or ceiling panel, only the camera's lens is visible.

Technical Data			
Lens Options	B016	Min. Light Sensitivity	Day Sensor: 0.1 lux at 1/60 sec Night Sensor: 0.02 lux at 1/60 sec
Image Sensors	1/1.8" CMOS (6MP) Day (Color) or Night (B&W)	Sensor Resolution	6MP: 3072x2048 pixels (Color/B&W)
Max. Frame Rate (MxPEG)	MEGA/HD: 30 fps, QXGA: 15 fps, 6MP: 8 fps	Compression	MxPEG, M-JPEG, JPEG, H.264 (SIP video only)
DVR Recording	Internal: microSD Card External: PC/NAS (to 4 TB)	Audio	2-way VoIP available with AudioMount or external microphone & SpeakerMount
Operating Conditions	IP65, IK06, -30 to +60 °C	Internal Sensors	Temperature, illumination, shock detector
Image Processing	MxActivitySensor, VMD, image correction, backlight, MxAnalytics	Software (free of charge)	MxManagementCenter, MOBOTIX App

S15M – One Camera Replaces Four

Like the Q25, the S15M is a Hemispheric camera that can display four different viewing angles on the monitor, from a single lens. Each of the four views has a virtual PTZ function and can be adjusted separately.

S15M – Low Light, No Problem

The maximum resolution of the color and B&W sensors is 6 megapixels. Thanks to the new color sensors that feature higher light sensitivity, it is now often possible to use MOBOTIX day cameras with color image sensors around the clock, even under low light conditions.



Hemispheric video: 180° wall-to-wall capture, no blind spots.

IP Video Door Station in triple frame with BellRFID and Info Module

The World's Most Advanced Door Station.

This modular IP Video Door Station, a one-of-its-kind, offers a combination of 6MP Hemispheric technology and integrated VoIP/SIP to provide full access control and a two-way video communication option – at home or via a mobile app while on the go.

Advanced IP Video Intercom Technology

Most video door stations are designed around analog TV technology. Such systems can only deliver very low image quality with limited 2-way communication. The new IP Video Door Station from MOBOTIX is based on the most up-to-date technology, incorporating megapixel Hemispheric video, RFID keyless access, digital voice messaging with seamless smart phone and PC access.



Hemispheric Video

Capturing a super-wide 180° field of view, the T25 camera module captures everything wall-to-wall for secure viewing and recording. The Hemispheric image correction is handled by the camera, no external PC required. The in-camera image correction saves bandwidth by up to 70 %.

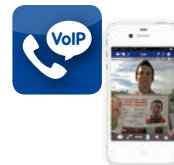

Instant 2-Way Communication – From Anywhere!

SIP/VoIP built-in for instant 2-way intercom communication. If the bell button is pressed, the camera records and a phone call or message can be sent directly to your PC, mobile or phone. A conversation can be initiated with the visitor, from wherever you are in the world.



Secure Access with RFID and Messaging

With the door station modules, keyless RFID and PIN access can be added to ensure secure door entry at all times. Visitors can leave voicemails and message retrieval is done instantly locally or remotely.

Technical Data			
Lens Options	B016	Min. Light Sensitivity	Day Sensor: 0.1 lux at 1/60 sec Night Sensor: 0.02 lux at 1/60 sec
Image Sensors	1/1.8" CMOS (6MP) Day (Color) or Night (B&W)	Sensor Resolution	6MP: 3072x2048 pixels (Color/B&W)
Max. Frame Rate (MxPEG)	MEGA/HD: 30 fps, QXGA: 15 fps, 6MP: 8 fps	Compression	MxPEG, M-JPEG, JPEG, H.264 (SIP video only)
DVR Recording	Internal: microSD Card External: PC/NAS (to 4 TB)	Audio	Integrated microphone & speaker, VoIP, intercom, sound recording
Operating Conditions	IP65, IK09, -30 to +50 °C	Internal Sensors	Temperature, microphone, illumination, shock detector.
Image Processing	MxActivitySensor, VMD, image correction, backlight, MxAnalytics	Software (free of charge)	MxManagementCenter, MOBOTIX App

Hemispheric IP Video Door Station – Simple and Cost-Effective Installation

The MOBOTIX IP Video Door Station can be connected and supplied with power via a standard network cable (PoE), or – thanks to the Mx2wire+ technology – via standard wiring such as bell wire, antenna cabling or coax.



T25 Camera Module

With a super-wide 180° field of view, the T25 camera module captures everything wall-to-wall. Includes programmable buttons for activating lights and a bell. Hemispheric image correction is handled by the camera, no additional software required. Built-in VoIP/SIP for instant 2-way communication via PC or mobile device.

Available in two models, MX-T25-D016 and MX-T25-N016



BellRFID

The weatherproof BellRFID module provides keyless entry, voice mailbox control and is available with any one of six available bell button sets. The bell button sets are customizable and can be exchanged at any time. The module allows visitors to record messages, which residences can play back locally or remotely. Includes mailbox feature, 1 admin and 5 user RFID cards.



Available with six different button sets, MX-Bell1-Button-F1/F2/F3/F4/05/XL1



KeypadRFID

The weatherproof KeypadRFID module provides keyless entry and voice mailbox control. The modules allow visitors to record messages, which residences can play back locally or remotely. Includes 1 admin and 5 user RFID cards.

MX-Keypad1-EXT-PW



Info Module

This weatherproof backlit display for showing an address or logo can be ordered with or without Mx2wire+ technology. When optioned with Mx2wire+, Ethernet cabling is not required, as the Mx2wire+ technology converts existing 2-wire telephone or electrical cable into a 10/100 PoE network.

Available in two models, MX-2wirePlus-Info1-EXT And MX-Info1-EXT.



Frames and Housings

All of the door station modules require a frame and housing for the purpose of wall mounting. Frames are available for in-wall and on-wall mounting. Includes unique anti-theft system for device security.



Different frames available for on-wall and in-wall mounting



MX-DoorMaster

This internal security door opener includes door access battery backup and encrypted security for the door access codes, to prevent unauthorized access. Compatible with standard door openers (6 to 12 V AC, 24 V AC/DC) using an external power supply. Available in white only.

In-wall: MX-Door2-INT-PW
On-wall: MX-Door2-INT-ON-PW

Modular System

MOBOTIX offers a varied selection of modules, which can be upgraded and interchanged within the door station at any time. All door station modules are fully weatherproof (IP65, except MX-DoorMaster).

The T25 and Door Station Modules are Available in 3 Colors



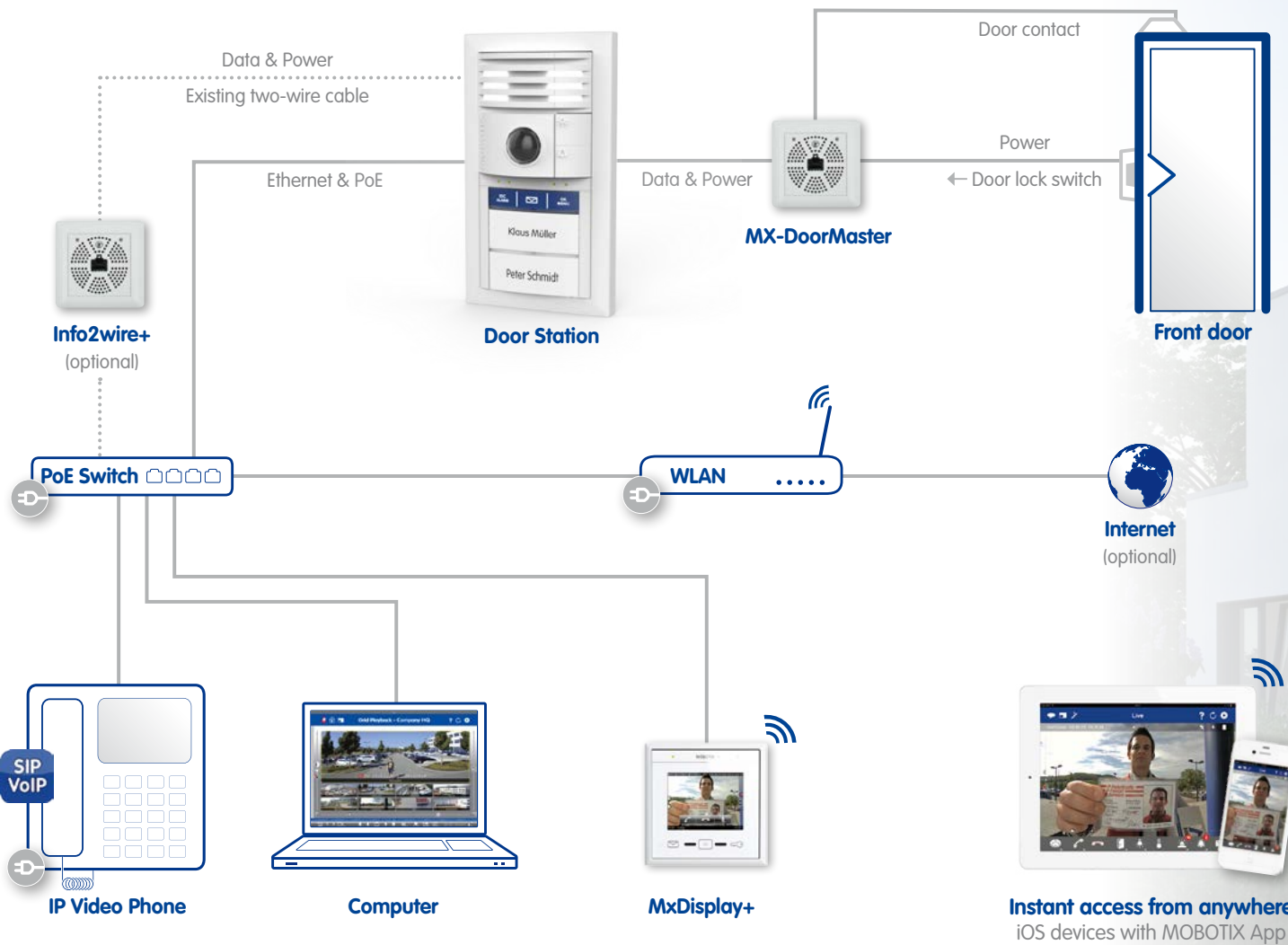

Fast, Cost-Effective Installation
 Existing doorbells and intercoms can be replaced with a MOBOTIX Door Station, because it's an end-to-end solution that can be installed anywhere, even if there is no existing network infrastructure, using Mx2wire+. Any number of additional video and access devices can be integrated to create a door access control solution that can be controlled from any location.

Instant access from anywhere
 iOS devices with MOBOTIX App

Complete 180° Panorama View. No Blind Spots.

The T25 core module is equipped with a Hemispheric lens and a 6MP image sensor allowing monitoring of an entire entrance area, capturing a complete 180° Panorama view from wall to wall and floor to ceiling.

Hemispheric IP Video Door Station – Simple Setup

The outdoor station requires just one cable for data and power to be connected to a PoE switch and thereby to any expandable Ethernet network. The T25 core module is also fitted with an internal MicroSD storage for convenient on-board storage, or alternatively can record to networked storage (NAS or PC).



Building Automation Server with Touchscreen Display for Viewing & Device Management.

MxDisplay+ is a wall-mountable Building Automation Server with touchscreen display, incorporating WiFi and RFID functionality. From this central glass terminal, you can add and configure all MOBOTIX devices. Multiple MxDisplay+ can be wirelessly connected, each being powered via PoE.

Smart Phone on the Wall

MxDisplay+ is often referred to as a "smart phone on the wall" because it can be operated using swipe and zoom gesture control, just like a smart phone. With a few swipes, the user can see an overview of several cameras, retrieve the latest video messages or create a new access transponder card for a visitor.

Touchscreen Viewing Station for the IP Video Door Station

MxDisplay+ serves as a wall-mountable remote viewing station for the MOBOTIX IP Video Door Station and cameras. Here are just a few of the many features available within the display:



Live View & Two Way Audio

Direct access to the T25 IP-Video door station as well as to all cameras in the network including live view and two way audio. Control of multiple Door Stations and cameras via a single MxDisplay+.



Quick Event Overview

MxDisplay+ show at one glance how many and what type of events were recorded. Accepted and denied access events are distinguished with a different color code.



Playback of Messages and Alarm Events

Fast research and playback of recorded videos of all door stations and cameras with gesture control. Scrolling through clips by simple finger swipes.



Access & Device Configuration

MxDisplay+ allows central controlling, configuration and access management, including all cameras, functional boxes and alarm sensors.



Screens and Soft Buttons

Depending on the application, user defined screens and buttons can be freely defined and configured. Comfortable user control of lighting, blinds, cameras, etc. can be done with MxDisplay+ or with the new MxSoftpanel from every PC or Mac.

Additional MxDisplay+ Features

- Full control of your lighting, heating, blinds, camera and alarm system
- Doors can be unlocked with the press of a button
- Excellent voice transmission quality thanks to HD wide-band audio codec (G.722)

100%
incl.

For PC/Mac



Professional VMS • No costs • No camera or user limits

The New Standard of Professional VMS.

MxManagementCenter (MxMC) the new video management software is a complete new development from scratch that focuses on a unique and intuitive user experience. MxMC is perfectly designed in combination with MOBOTIX cameras representing the decentralized concept at its best. Following the MOBOTIX software concept, MxMC is 100% included in the MOBOTIX product offering, requiring no extra software, license or update costs and at the same time having no limits in terms of users, screens and cameras.

100% included

Different Platforms and Standards

MOBOTIX is offering one of the most competitive and user friendly VMS solutions, running on PC and Mac. MxMC is also open to interact with H.264/ONVIF compatible cameras in the future.

Intuitive Layout View – Cameras and Groups

MxMC helps users to manage huge amount of cameras by sorting and structuring devices into groups and different layout views. MxMC is structured in 4 major areas:

1. Group or camera bar

Perfect preview of all available cameras and groups.

2. Layout area supporting grid, graphic and info view

Major display area for grid layout including focus and grid windows, graphic view supporting intuitive layout constructions with symbols and background images as well as an information screen where support, emergency or and additional project information is displayed. All 3 views can be toggled and selected with a single click.

3. Intelligent alarm bar

Chronological preview of all alarms. The complete alarm bar can be suppressed or displayed. All previews can be directly selected or filtered and sorted by cameras and type of events. With drag&drop every alarm can be moved into focus window for live view or player view for deeper analysis. Vice versa, complete groups or selected cameras can be dragged into the alarm bar for analysis.

4. Command bar

Includes all buttons for different views, player and research, history, layout editing, management and control functions.

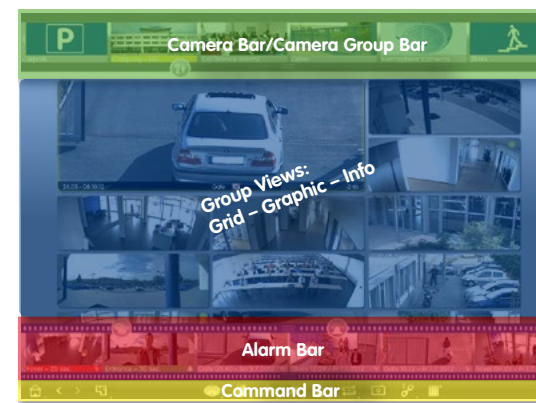

Fastest Learning Curve

MxMC does not need a huge user manual or other heavy documentation to get started. MxMC is one of the most intuitive video management systems on the market.

Highlights

- Gesture Control: Touchscreen drag&drop interface
- High-speed Research: 60-times playback speed and comfortable time lapse
- Event Statistics: Frequency and cumulations with histogram
- POS Integration: Video supported inventory analysis
- Device Bar: Perfect overview with tree structure
- Multi-Monitor: Easy setup of monitor walls
- Mobile Playback: Adaptive bandwidth management

User Experience

The new MOBOTIX Management Center (MxMC) is a complete new development for PC/Mac systems with the focus on a unique and intuitive user experience, providing the highest cost savings and flexibility in the market.



Unlimited • Free of Charge

Following the MOBOTIX software concept, MxMC is 100% included in the MOBOTIX portfolio, requiring no extra software, license or update costs. MxMC can be used in projects independent of the number of cameras or the mix of products. It is possible to setup a complete system in the shortest time.

Intuitive Layout Views

MxMC helps users to manage huge numbers of cameras by sorting and structuring devices into groups and different layout views. MxMC supports grid, graphic and info view as well as camera-, group- and alarm bar to get fastest overview and results.

Multi Slider

MOBOTIX has revolutionized selection and control of parameters. With Multi Sliders, the user is able to manage multiple parameters in one selection line. Multi Sliders are available in grid, graphics and player view as well as in all different research and configuration screens. Multi Slider is the fastest selection tool to define image settings, zoom views, set aspect ratios or to filter events and cameras. Multi Slider buttons also provide "jump tags" via context menus for direct selection.

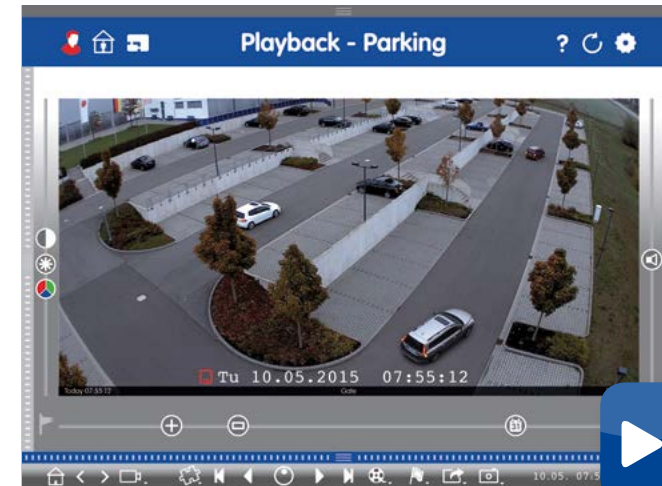

High-speed playback



MOBOTIX Hemispheric Dewarping

MxMC is able to dewarp hemispheric fisheye views, supporting keyboard, mouse, trackpad and joystick to allow easiest and fastest tracking.

MOBOTIX Hyperlinks

MxMC is able to interact with 3rd party IP devices and supports the setup of hyperlink buttons to integrate devices like IOs or home servers and MxBus modules via MOBOTIX cameras.



User Action Log

MxMC supports a full user logging functionality of user actions like starting playback or export, switching audio on, etc. in order to establish a complete user protocol. In this way all user responses can be logged and documented to create a complete chain of evidence.

Multi-Monitor-Capability

MxMC offers setup and arrangement of dual or multi-monitor installations without any software costs. A simple double-click leads to the second monitor. Or MxMC is able to detect multiple monitors from different PCs in the network and can define target monitors for individual cameras or views.

60-times High-speed Playback

MxMC includes different research tools to provide fastest results on events and recordings, comfortable research and in- depth analysis. 60-times high-speed playback with time lapse search reduces a 24-hour video footage down to nearly one minute for example.

MxPOS

Search and sort function of data created by the POS system. For example, checkout transactions can be analyzed by items, price or staff member. Beside video security, MxMC offers the image and video to the related transaction analysis and key word search.

Playback Analysis • Plugins

Automatic post video motion analysis allows High-speed search including time lapse of the complete video footage to find particular motion events. MxMC provides a new plugin interface for future software features or third-party developments like post video motion analysis, bar code scanning or number plate recognition. This will open up a great number of new applications for MxMC and allows partners and system integrators to use MxMC in many new market verticals and segments.



Grid view



Graphic view



Multi-Monitor



Grid playback



High-speed playback



Virtual PTZ



MxPOS (Point Of Sale)



Alarms



Plugins



MxEventStatistics

Adaptive Bandwidth Management

High definition video is exclusively recorded by the MOBOTIX cameras. They are able to manage frame rates and image resolution, depending on the available bandwidth. Even during small bandwidth connections, virtual PTZ is able to zoom into areas of interest to retrieve every detail. This unique feature is available in both live video and playback.

Perfect Overview with Tree Structure

The new device bar displays a new tree structure in all layout views and supports a clear structure, an easier management with filtering of groups and the respective cameras by folding and unfolding branches. The size of the device bar can be adjusted individually and contains definable favorites which can be cameras, video clips and devices.

Flexible Video Export

MxMC allows the export of the complete video as an overview or the zoomed part of the image in different formats (mxg, avi, etc.). This new function supports the export into different resolutions, frame rates, virtual PTZ views, including the transformation from 360° hemispheric (fisheye) to surround, panorama or special views independent from the export source.

Histogram with MxEventStatistics

The display of events in a Histogram allows a fast graphical analysis of irregularities and related information. This is a perfect tool to get a quick overview of all events from the database, generated inside the camera without any additional PC.

60-times High-speed Playback

MxMC offers comfortable research and in-depth analysis for fastest results, on the spot analysis and short reaction times.

Highest Return of Investment

The unique concept of MOBOTIX Management Center (MxMC) and cameras provide the highest cost savings for users. No software costs, no license and update fees will generate the highest return of a future-proof investment.



Compatible with the iPad, iPhone and iPod Touch.

Stay in Control While You're on the Go.

Turn your Apple iOS device into a mobile surveillance station with this featurerich App from MOBOTIX. Now you can stay in constant contact with your MOBOTIX cameras from anywhere in the world. The App is compatible with the iPad, iPhone and iPod touch. Download it from the App Store today!

100% included

Premium iOS Software

The MOBOTIX App offers advanced features, such as voice mailbox retrieval, camera grouping, event filtering and bandwidth optimization – no central DVR is required. The MOBOTIX App is fully compatible with the entire range of MOBOTIX cameras.

Instant Communication



When a bell button is pressed or motion is detected, you are notified with a phone call.

Alarm Notification



If an alarm trigger occurs, the camera will start recording and sends an alarm message.

Bandwidth Optimization



Live video streaming is optimized automatically as you move between WiFi and mobile (3G/4G) networks while recording HighRes locally.

Fast Event Searching



Logical filtering for faster search and playback of recorded events.

View Your MOBOTIX System from Anywhere

The MOBOTIX App provides instant access to your MOBOTIX surveillance systems via WiFi, 3G/4G connections. This free viewing client is compatible with all Apple iOS devices such as the iPhone, iPad and iPod Touch.

Other Features

- Control external devices, such as doors/gates and switching lights on/off.
- All data communication is encrypted using an SSL connection.
- Receive instant notification of incidents, conveniently view and play back recorded events.



MxActivitySensor registers only traveling movement of people and objects in the scene, reducing false alarms.



Motion Detection Has Been Re-Invented!

MxActivitySensor is a revolutionary technology that only registers movements of people and objects, while dismissing all redundant changes in the scene like shaking trees in the wind or moving camera poles. This drastically reduces the number of false alarms of more than 90 %.

100% included

"MxActivitySensor is a completely new technology that is literally five years ahead of existing video motion detection systems. We believe it is a game changer and as with all MOBOTIX software, it is available for free."

Dr. Ralf Hinkel, MOBOTIX Founder

Game-Changing Technology

MxActivitySensor surpasses traditional motion detection for accurately detecting general human and vehicular activity. This revolutionary technology is years ahead of all other video motion detection (VMD) systems.

Decentralized Management

MxActivitySensor is managed by the camera. No central DVR required for the image analysis and alarm handling. This represents huge savings in bandwidth and software/hardware costs. MxActivitySensor is available in camera software version 4.1.6 and higher.

Single-Click Configuration

Enabling MxActivitySensor takes a single mouse click to self-configure and adapt to the scene, so there is no need for a specialist to do the configuration. Left at the default settings, it is more accurate than a complicated video motion detection setup.

Directional Alarming

Specific directions of movement (up/down/left/right) can be setup as relevant events that trigger an alarm for recording, phone call, activate alarm etc. This way, it is possible to capture movements going against the direction of traffic on a one-way street, for example.

MxActivitySensor Detects Only What's Important

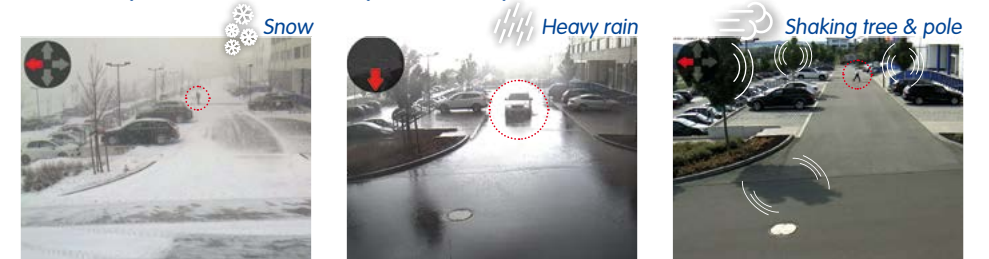

*In this sequence, captured by a MOBOTIX camera during a storm, only the moving vehicle is registered, while changes in the scene such as trees swaying, water on the lens and lightning flashes, are all ignored. This world-first in-camera technology **can reduce false alarms in cameras located outdoor of more than 90%.***

See MxActivitySensor in Action

To see a video demonstration of MxActivitySensor, go to www.mobotix.com > Products > MxActivitySensor. For detailed information relating to configuration and setup, please refer to the MxActivitySensor Compact Guide available at www.mobotix.com > Support > Media Library > Compact Guides.

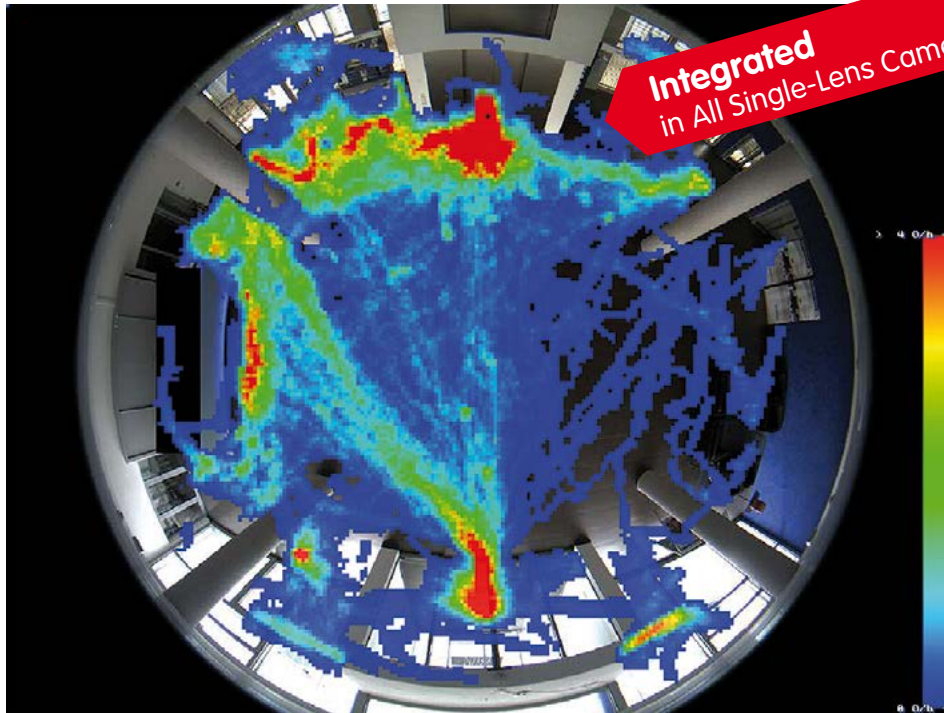

Heat map: The areas with the most movement are shown in red, and those with little movement in blue.

Camera-Integrated Video Analysis.

MxAnalytics makes it possible to collect statistical behavior data on people and objects. This is done by defining recognition zones and counting corridors. The camera then records how often the object moved through each counting corridor within a specified time period. The most frequented areas are highlighted in color as a heat map. Best results with hemispheric cameras.

100 % included

MxAnalytics – Highlights:

- Live analysis without network load, decentralized in the camera
- No additional devices like computers, servers or black boxes required
- Video analysis software available free of charge with no usage restrictions
- Also available free of charge for previously installed cameras via firmware update (MX-V4.3.2.45 or higher)

Visualize Highly Frequented Areas (Heat Maps)

Which shelves in the shop attract the most customers? Which paintings by the new artist hold the attention of the visitors most? Which waiting areas in the departure hall are preferred in the afternoon? To answer questions like these, all movements of objects of a particular size are recorded and evaluated, either in the live image or in a previously defined detection area. The frequency of the movements is shown visually by means of different colors in a heat map.

Count People or Objects (Counting Corridors)

You can define counting corridors in the camera live image to find out, for example, how many people walk in and out of each entrance of a shop. The camera records how often each counting corridor is crossed within a specified period.

MxAnalytics Extensions for Behavioral Detection

“Undesired” motion patterns of objects and people can now trigger events, when using a 6MP camera c25, Q25 and S15M in-ceiling installations:

- Corridor: Count objects in a defined corridor
- Duration of stay: Object/person exceeds a defined time staying in the image area
- Opposite direction: Object moves against main direction
- Turn: Object changes direction between 45° and 135°
- U-Turn: Object suddenly reverses direction
- Speed: Object/person exceeds the defined speed (m/s)
- Restricted Area: Object moves into forbidden zone.



Object or people statistics



Multiple behavioral events



- Easy configuration and intuitive operation for the user
- Automatic counting corridor and heat map reports
- Counting corridor solution can be configured to only count objects that move in a predefined direction
- Detection of unexpected movement patterns within defined areas

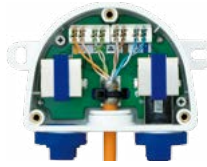

MX-Protection-Box

Protection-Box

This network protection box allows you to protect your MOBOTIX camera from damage caused by electrical surges of up to 4,000 volts that are triggered, for example, by voltage fluctuations, high-voltage loads and lightning strikes nearby. Used to establish an Ethernet connection using a MOBOTIX patch cable (RJ45) or via a single-wire terminal connector with an ETH installation cable.

MX-Overvoltage-Protection-Box-RJ45
MX-Overvoltage-Protection-Box-LSA



MX-NPA-Box

NPA-Box, PoE-Injector

The Network Power Adapter (NPA) box is used to connect a camera to the network and supply power from external power supplies or batteries from **12 to 57 V DC**. Ideal for battery-powered mobile surveillance units.

MX-OPT-NPA1-EXT



MX-GPS-Box

GPS-Box

GPS timer for MOBOTIX systems. Includes temperature and illumination sensors for outdoor use and an NTP time server for system synchronization. Tracking functions and alarms can be configured in the camera software based on position, speed, illumination and temperature. The box is connected via MxBus to a MOBOTIX camera.

MX-OPT-GPS1-EXT



MX-Proximity-Box

Proximity-Box

Connected to a MOBOTIX camera via MxBus wires, this interface box enables motion detection with direction and distance detection up to max. 10 m/33 ft. based on radar microwaves. It can be mounted behind walls (e.g. wooden, plastic, dry walls) and is a MOBOTIX alternative to PIR.

MX-OPT-PROX1-EXT



MX-Input-Box

Input-Box

Flexible camera sensor expansion by connecting up to six external sensors per box (for example, window and door contacts, light barriers etc.). The MX-Input-Box is a peripheral device that connects to the camera via MxBus and provides it with six galvanically isolated, self-powered inputs.

MX-OPT-Input1-EXT



MX-Output-Box

Output-Box

Flexible system expansion with connection of up to eight peripheral devices per box (for example, power relay for lighting, garage door drive, blinds, etc.). In addition to the four MxBus terminals, the MX-Output-Box includes a total of eight signal outputs, of which six are self-powered (12 V DC, max. 10 mA per output) and two are potential-free.

MX-OPT-Output1-EXT



232-IO-Box

Expansion box for connecting external sensors and for switching external devices via MOBOTIX cameras; RS232 interface, connection to camera via MiniUSB or MxBus. Includes two galvanically isolated, self-powered signal inputs and two 12 V relay outputs. One 232-IO-Box can be connected to the camera's USB port and one to the camera's MxBus port to double the number of signal inputs and outputs.

MX-OPT-RS1-EXT



BPA-Box

The task of the MX-BPA-Box (Bus Power Adapter) is to assume sole responsibility for providing all power for every MxBus module connected to a camera. With a connected external voltage source of 24 to 48 V DC up to seven MxBus devices can be powered at the same time (output power: 9 W).

MX-OPT-BPA1-EXT



Secure Installation of Interface Boxes

All interface boxes are weatherproof (IP65, -30 to +60°C) and feature a highly compact design (width: 8 cm). They can be mounted securely out of reach in the M15 and M25 VarioFlex wall mounts or in the D15 and Q25/D25 wall mounts (see figure).

What Is MxBus?

The interface boxes are connected via MiniUSB or MxBus directly to a camera and are powered by it as well. MxBus is a MOBOTIX-developed, encrypted, two-wire bus system up to 100 m in length and is used to flexibly add new functions to a video system.



Intercom Device with Sensors and Inputs.

The ExtIO module extends the functionality of your MOBOTIX camera, providing 2-way intercom communication via its in-built microphone and speaker. It also includes a passive infrared motion sensor, a temperature sensor and additional signal inputs/outputs. The two programmable buttons are ideally suited for activating camera functions and external electronic devices. The ExtIO can be connected to a MOBOTIX camera directly via USB or network switch.

MX-EXTIO

ExtIO Overview	
Interfaces	USB, Ethernet 10/100 Mbps
Intercom	Microphone and speaker, integrated amplifier
Inputs	2 x galvanically isolated input contacts
Outputs	2 potential-free output contacts, safe extra-low voltage (AC/DC, max load 100 mA)
Sensors	- Passive IR motion sensor (PIR) - Temperature sensor - Illumination sensor - 2 programmable buttons
Status Display	Two status LEDs
Protection Class	IP65 (DIN EN 60529)
Operating Temperature	-30 to +60 °C
Power Supply	USB, Power over Ethernet (IEEE 802.3af, Class 2)
Wattage	typ. 1 W
Dimensions	diam. xH: 16 x 4.5 cm

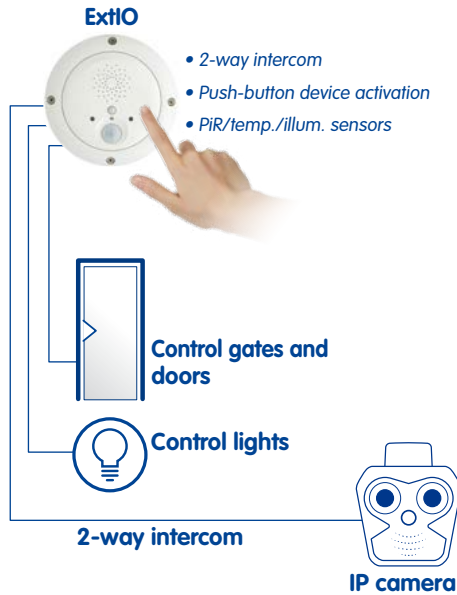





PoE Injector to Power Your MOBOTIX Device.



- Powers all MOBOTIX cameras and PoE devices.
- Connects directly to standard mains power.
- Camera-to-PC connection without needing a switch.
- Can draw power from batteries (12 to 57 V DC).
- Powers any standard PoE (IEEE 802.3af) devices, such as VoIP phones, IP cameras etc.
- Connects to a PoE device using Ethernet cable.

MX-NPA-PoE-INT-Set

NPA-PoE Set	
	Power Supply and Injector Universal power supply 24 V DC/ 750 mA with exchangeable plug
	EU plug For operation in Europe
	UK plug For operation in UK
	US plug For operation in North America
	AUS plug For operation in Australia
Accessories	
	Cable for 12–24 V battery connection • Cable length 2.0 m/6.56 ft • 1x RJ45 (injector) connector • 1x connector +/- (voltage source)

PoE Injector Overview	
Connectors	3x RJ45 (LAN/Power, PC/Power, camera)
Input	12 V to 57 V DC
Output	DC 48 V; PoE (IEEE 802.3af: PoE classes 1 to 3) 16 V input voltage or higher, PoE classes 1 and 2 (max. 6.49 W) at 12 V to 16 V
Deactivating	Less than 10 V input voltage
Operating Conditions	Indoor
Dimensions	LxWxH: 6 x 5.5 x 2.7 cm
Weight	about 40 g
Special Features	Integrated crossover for direct connection to PC; connection to power supply or battery 12 V or higher

ExtIO – Intelligent Technology for Combined Systems

The practical and functional ExtIO module can be easily combined with all MOBOTIX cameras and enables door and gate intercoms to be integrated with your MOBOTIX system.

Robust, Proven Power Supply for MOBOTIX Devices

The NPA-PoE Set is specifically designed for powering MOBOTIX devices. Our high-quality PoE injector includes three connection ports for network, camera/PoE device and computer.

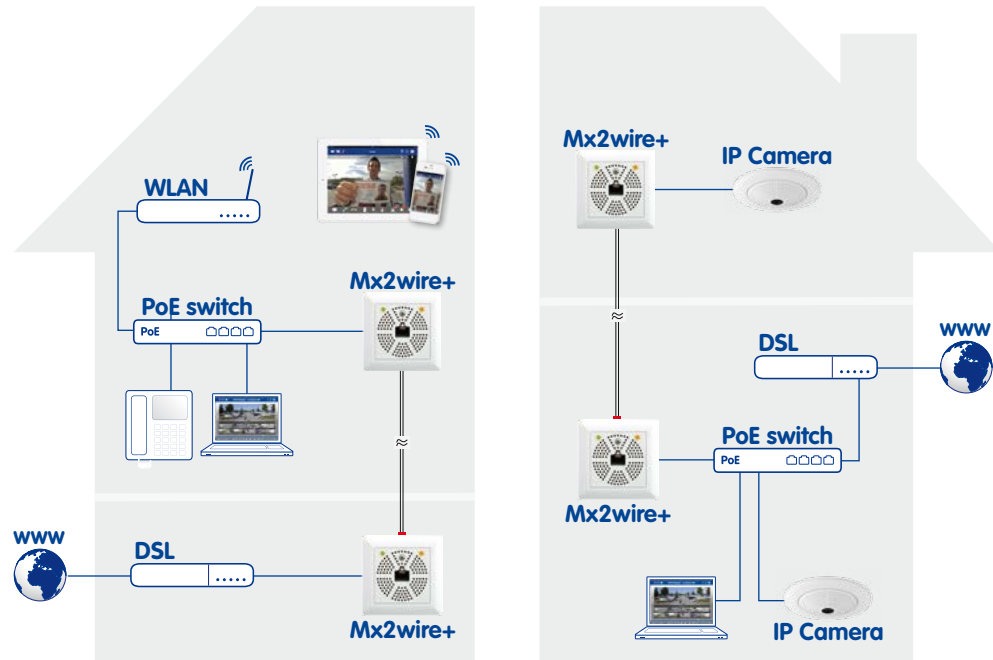

Mx2wire+ converts standard 2-wire cabling into a PoE network connection.

Convert Standard 2-Wire Cable into PoE.

Mx2wire+ turns existing two-wire cabling into a powered Ethernet (PoE) network – quickly and cost-effectively. This means you don't need to have any Ethernet cabling installed to connect and network your IP cameras and PoE devices. All you need is Mx2wire+. Each Mx2wire+ kit includes two units.

Cost Savings

The significant benefit of Mx2wire+ is that, in addition to data connectivity, the power can also be transferred via the two-wire cable, to PoE devices such as MOBOTIX IP cameras, for example. This can literally save you thousands in cabling costs.

Extended Connection

With the right cabling, Mx2wire+ can send video data at a distance of up to 500 meters; data rate up to 45 Mbps, depending on cable quality and distance.

Standards-Compliant

Connected devices are supplied with up to 13 watts via Power over Ethernet, which is compliant to the IEEE 802.3af standard.

Info2wire+ – Special Product Version for MOBOTIX IP Video Door Station

The optional Info2wire+ module for the IP Video Door Station can be combined with an Mx2wire+ unit. Helps to quickly establish the power supply via an existing phone line and to connect the door station to the network.

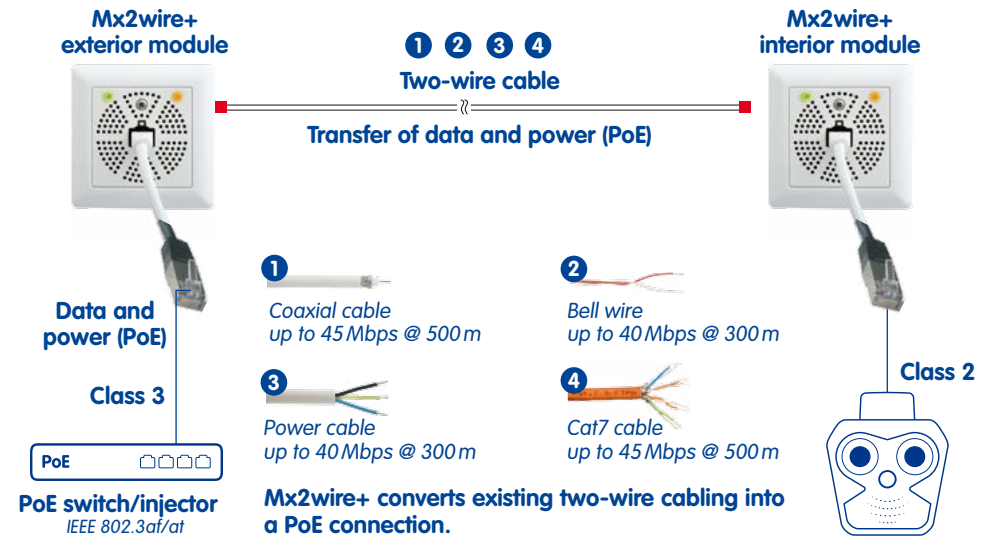

1 Coaxial cable
up to 45 Mbps @ 500 m

2 Bell wire
up to 40 Mbps @ 300 m

3 Power cable
up to 40 Mbps @ 300 m

4 Cat7 cable
up to 45 Mbps @ 500 m

PoE switch/injector
IEEE 802.3af/at

Mx2wire+ converts existing two-wire cabling into a PoE connection.

Mx2wire+ – Saves on Installation Costs

Mx2wire+ can create a computer network via analog cabling such as an unused telephone line or antenna cable. The Mx2wire+ can be used to connect a computer, IP cameras and even the new IP Video Door Station intercom system. It will also power standard PoE devices.

Mx2wire+ – Power Supply on Customer Requirements

Mx2wire+ requires a voltage supply by a standard PoE switch (class 0 or class 4, IEEE 802.3af/at) for its own consumption as well as for supplying power to the connected PoE end device. This can either be the NPA-PoE-Set by MOBOTIX or a DC power supply unit (48 to 57 V, 600 mA).



DualMount



The DualMount houses two S15 sensor modules, for discreet day and night video capture. The sensor modules are angled downwards to avoid covering irrelevant areas such as ceilings or the sky. Designed for indoor and outdoor ceiling mounting. Compatible with all S15 sensor modules, allows for dual hemispheric capture.

MX-FLEX-OPT-DM-PW
For all optical S15 sensor modules

PTMount



The PTMount converts S15 sensor modules into a robust IP dome camera that can be both wall or ceiling-mounted. The adjustable dome features a unique three-axis system allowing re-alignment that compensates for sideway tilt. This ensures that the sensor module can be correctly positioned for a perfect image capture (PTMount-Thermal see page 15).

MX-PTMount-OPT-PW
For all optical S15 sensor modules

SurroundMount



Designed for monitoring long, narrow areas (corridor, bus, train, etc.). By perfectly aligning two sensor modules at a 25° angle in opposite direction, two Hemispheric sensor modules can even cover an entire corridor – no blind spots.

MX-FLEX-OPT-SM-PW
For all optical S15 sensor modules B016 (L10), B041 (L22), B079 (L43)

SpeakerMount



This high-quality speaker connects directly to the S15 via a two-wire cable and requires no additional power. Suitable for installation in ceilings or walls, indoors only. Available in white or matt chrome finish. In conjunction with the microphone built into the sensor modules, it turns the S15 into a 2-way communication system.

MX-HALO-SP-EXT-PW
For all S15 cameras

HaloMount



For installations where discretion and design consideration is important. This stylish high-quality wall/ceiling metal mounting bracket comes in five versions (matt chrome, glossy chrome, brushed nickel, white or black). Compatible with single-sensor modules or down-lights. Sensor modules placed into the HaloMount can be tilted up to 20 degrees, for perfect capture.

MX-HALO-EXT-PW
For all optical S15 sensor modules

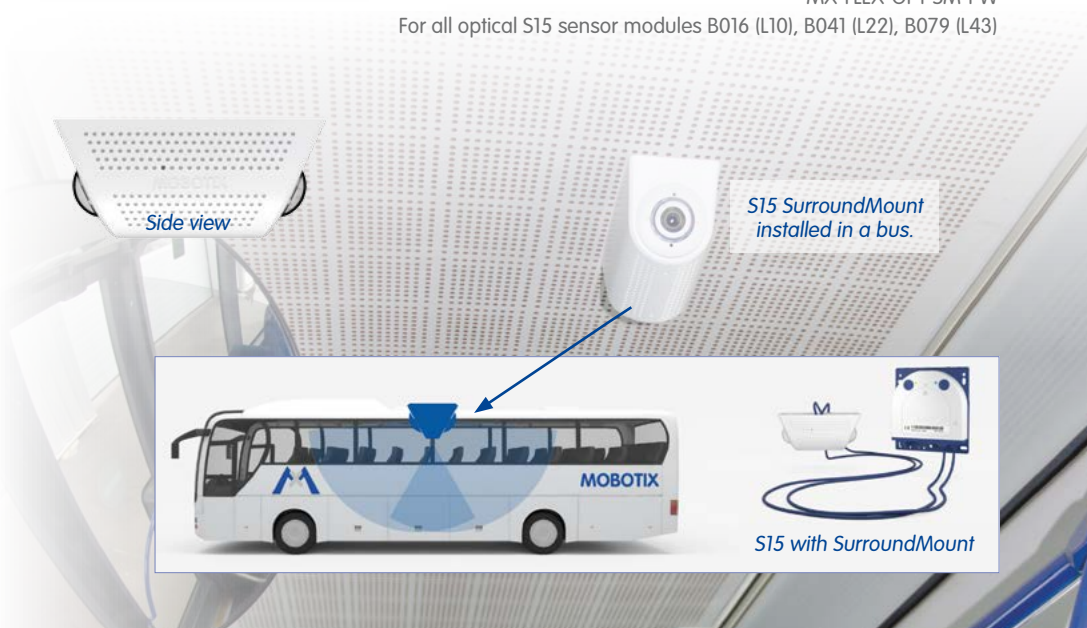

Hemispheric Video Improves Transportation Security

The Stadtwerke Kaiserslautern (SWK) public utility company makes bus transportation more secure with mobile IP video systems from MOBOTIX. A MOBOTIX FlexMount camera connected to a monitor shows the driver what is happening in the bus.

These mounts are also available in black without additional costs:



DualMount



SurroundMount



PTMount



Optical sensor modules are compatible with the M15 and S15.

Modular Imaging System.

Each sensor module consists of a lens, image sensor and microphone. Designed for the M15 and S15, the modules can be interchanged within minutes, at any time. The modules are weatherproof (IP66) and can be installed both indoors and outdoors. Choose between optical and thermal sensors.

Sensor Modules Technical Overview

Image Sensors	1/1.8" CMOS (6MP) Day (Color) or Night (B&W)	Sensor Resolution	6MP: 3072x2048 pixels (Color/B&W)
Operating Conditions	IP66, -30 to +60 °C	Audio	Microphone in each module (except thermal modules, BlockFlexMount, CS mount and B500)

Easily Exchangeable Sensor Modules

The MOBOTIX S15/M15 modular system allows the sensor modules to be changed within minutes. This way, the camera optics, such as the field of view or sensor type can be easily exchanged.

S15 Thermal Sensor Modules



Thermal Sensor Modules (for flush mounting)
MX-SM-Thermal-L43
MX-SM-Thermal-L65
MX-SM-Thermal-L135

PTMount-Thermal (with integrated thermal sensors)
MX-SM-PTMount-Thermal-L43
MX-SM-PTMount-Thermal-L65
MX-SM-PTMount-Thermal-L135

The thermal sensors can be retrofitted and easily connected to the S15 with a sensor cable (max. length 3 m). The sensor modules cannot be individually replaced in the PTMount-Thermal. For information on the M15-Thermal Thermographic Camera, see page 12.

D15 Lens Units with Long Pass Filters (LPF)



The D15 camera housing includes two lens units that can be combined as required. They can be moved, thus making a precise alignment to the areas to be recorded possible.

S15 BlockFlexModule



Available MOBOTIX lens options:
B036, B041, B061, B079, B119, B237, B500

CS-Mount BlockFlexModule



MX-BFM-CS-D (Day)
MX-BFM-CS-N (Night)
MX-BFM-CS-N-LPF (Night-LPF)
Recommended MOBOTIX lens:
CSVario MX-B045-100-CS

Dual Camera Technology from MOBOTIX for Day and Night Recordings



Only MOBOTIX day-and-night cameras are able to offer a day and night sensor designed to ensure optimum image quality at all times. Both lenses capture the same area. The purely digital switchover between day and night sensors helps deliver higher image quality and guarantees a longer lifetime for the cameras.



More Than Just a Lens

Optical sensor modules (IP66) have a lens, an image sensor, built-in microphone and two status LEDs. The sensor modules are connected to the M15 and S15 via specially designed gigabit video cables. Mounting accessories for the S15 (e.g., SurroundMount, DualMount, PTMount) are also available, making it the ideal choice for a wide range of surveillance applications.



	B016 Fisheye	B036 Ultra Wide Lens	B041 Super Wide Lens	B061 Wide Lens
Image angle (horizontal)				
Focal length	1.6 mm	3.6 mm	4.1 mm	6.1 mm
35 mm equivalent	10 mm	20 mm	22 mm	32 mm
Aperture f/	2.0	1.8	1.8	1.8
Image angle (horiz. x vertical)	180° x 180°	103° x 77°	90° x 67°	60° x 45°
Image width/height (dist. 1 m)		2.5 / 1.6 m	2.0 / 1.3 m	1.2 / 0.8 m
Image width/height (dist. 10 m)		25.1 / 15.9 m	20.0 / 13.2 m	11.5 / 8.3 m
Image width/height (dist. 50 m)		125.7 / 79.5 m	100.0 / 66.2 m	57.7 / 41.4 m

Maximum distances in meters @ 5MP (2592 x 1944 Pixel)

Monitor (1 px $\hat{=}$ 80 mm)	13.7 m	115.3 m	132.0 m	208.0 m
Detect (1 px $\hat{=}$ 40 mm)	6.9 m	57.6 m	66.0 m	104.0 m
Observe (1 px $\hat{=}$ 16 mm)	2.7 m	23.1 m	26.4 m	41.6 m
Recognize (1 px $\hat{=}$ 8 mm)	1.4 m	11.5 m	13.2 m	20.8 m
Identify (1 px $\hat{=}$ 4 mm)	0.7 m	5.8 m	6.6 m	10.4 m
Inspect (1 px $\hat{=}$ 1 mm)	0.2 m	1.4 m	1.6 m	2.6 m



	B079 Standard	B119 Tele	B237 Distant Tele	B500 Super Tele	B045-100-CS CS Vario
Image angle (horizontal)					
Focal length	7.9 mm	11.9 mm	23.7 mm	50 mm	4.5 - 10 mm
35 mm equivalent	43 mm	65 mm	135 mm	270 mm	24 - 54 mm
Aperture f/	1.8	1.8	1.8	2.5	1.6 - 2.3
Image angle (horiz. x vertical)	45° x 34°	31° x 23°	15° x 11°	8° x 6°	39°-89° x 29°-65°
Image width/height (dist. 1 m)	0.8 / 0.6 m	0.6 / 0.4 m	0.3 / 0.2 m	0.1 / 0.1 m	
Image width/height (dist. 10 m)	8.3 / 6.1 m	5.5 / 4.1 m	2.6 / 1.9 m	1.4 / 1.0 m	
Image width/height (dist. 50 m)	41.4 / 30.6 m	27.7 / 20.3 m	13.2 / 9.6 m	7.0 / 5.2 m	

Maximum distances in meters @ 5MP (2592 x 1944 Pixel)

	290.2 m	441.0 m	888.8 m	1,781.0 m	
	145.1 m	220.5 m	444.4 m	890.5 m	
	58.0 m	88.2 m	177.8 m	356.2 m	
	29.0 m	44.1 m	88.9 m	178.1 m	
	14.5 m	22.0 m	44.4 m	89.0 m	
	3.6 m	5.5 m	11.1 m	22.3 m	

DIN EN 50132-7

As specified in the DIN EN 50132-7 standard, there are six different levels of quality for video surveillance. "Inspect" is the level with the highest demands on image quality, whereas "Monitor" is the one with the lowest. These can be used to determine the maximum distance between camera and surveillance area, the required minimum resolution, and the most suitable camera lens for optimal coverage of the surveillance area.

Notes on the Table:

- px = pixels
- Online planning tool (optics): www.mobotix.com > Support > Planning Tools



	B016 Day	B016 Night	B036 Day	B036 Night	B041 Day	B041 Night	B061 Day	B061 Night	B079 Day	B079 Night	B119 Day	B119 Night	B237 Day	B237 Night	B500 Day	B500 Night	Vario Day	Vario Night
Indoor Single Lens																		
i25	●	⊕	●	⊕	-	-	-	-	-	-	-	-	-	-	-	-	-	-
i25 Audio	●	⊕	⊕	⊕	-	-	-	-	-	-	-	-	-	-	-	-	-	-
c25	●	●	●	⊕	-	-	-	-	-	-	-	-	-	-	-	-	-	-
c25 Audio	●	⊕	⊕	⊕	-	-	-	-	-	-	-	-	-	-	-	-	-	-
p25	●	⊕	●	⊕	-	-	⊕	-	⊕	-	⊕	-	⊕	-	-	-	-	-
p25 Audio	●	⊕	⊕	⊕	-	-	-	-	-	-	-	-	-	-	-	-	-	-
p25 Body	-	-	🌿	🌿	🌿	🌿	🌿	🌿	🌿	🌿	🌿	🌿	🌿	🌿	🌿	🌿	-	-
p25 Body Night	-	-	🌿	🌿	🌿	🌿	🌿	🌿	🌿	🌿	🌿	🌿	🌿	🌿	🌿	🌿	-	-
p25 Body Audio	-	-	🌿	🌿	🌿	🌿	🌿	🌿	🌿	🌿	🌿	🌿	🌿	🌿	🌿	🌿	-	-
v25	-	-	●	-	-	-	-	-	-	-	-	-	-	-	-	-	-	-
v25 Body	-	-	🌿	🌿	🌿	🌿	🌿	🌿	🌿	🌿	🌿	🌿	🌿	🌿	🌿	🌿	-	-
v25 Body N	-	-	🌿	🌿	🌿	🌿	🌿	🌿	🌿	🌿	🌿	🌿	🌿	🌿	🌿	🌿	-	-
v25 Body Black	-	-	🌿	🌿	🌿	🌿	🌿	🌿	🌿	🌿	🌿	🌿	🌿	🌿	🌿	🌿	-	-
v25 Body N Black	-	-	🌿	🌿	🌿	🌿	🌿	🌿	🌿	🌿	🌿	🌿	🌿	🌿	🌿	🌿	-	-

	B016 Day	B016 Night	B036 Day	B036 Night	B041 Day	B041 Night	B061 Day	B061 Night	B079 Day	B079 Night	B119 Day	B119 Night	B237 Day	B237 Night	B500 Day	B500 Night	Vario Day	Vario Night
Outdoor Single Lens																		
D25	-	-	⊕	⊕	⊕	⊕	⊕	⊕	⊕	⊕	⊕	⊕	⊕	⊕	-	-	-	-
D25 Body	-	-	🌿	🌿	🌿	🌿	🌿	🌿	🌿	🌿	🌿	🌿	🌿	🌿	-	-	-	-
D25 Body Night	-	-	🌿	🌿	🌿	🌿	🌿	🌿	🌿	🌿	🌿	🌿	🌿	🌿	-	-	-	-
M25	●	⊕	⊕	⊕	⊕	⊕	⊕	⊕	⊕	⊕	⊕	⊕	⊕	⊕	⊕	⊕	-	-
M25 Body	-	-	🌿	🌿	🌿	🌿	🌿	🌿	🌿	🌿	🌿	🌿	🌿	🌿	🌿	🌿	-	-
M25 Body Night	-	-	🌿	🌿	🌿	🌿	🌿	🌿	🌿	🌿	🌿	🌿	🌿	🌿	🌿	🌿	-	-
Q25	●	●	-	-	-	-	-	-	-	-	-	-	-	-	-	-	-	-
Q25 Black	⊕	⊕	-	-	-	-	-	-	-	-	-	-	-	-	-	-	-	-
S15M	●	●	-	-	-	-	-	-	-	-	-	-	-	-	-	-	-	-
T25 White	●	●	-	-	-	-	-	-	-	-	-	-	-	-	-	-	-	-
T25 Silver (s)	●	●	-	-	-	-	-	-	-	-	-	-	-	-	-	-	-	-
T25 Black (b)	●	●	-	-	-	-	-	-	-	-	-	-	-	-	-	-	-	-
T25 Set 1, 2, 3	●	-	-	-	-	-	-	-	-	-	-	-	-	-	-	-	-	-
T25 Set 1, 2, 3 (s)	●	-	-	-	-	-	-	-	-	-	-	-	-	-	-	-	-	-
T25 Set 1, 2, 3 (b)	●	-	-	-	-	-	-	-	-	-	-	-	-	-	-	-	-	-
V15M	-	-	-	-	⊕	-	-	-	⊕	-	-	-	-	-	-	-	-	-

● Standard Program: Available lens/sensor configuration
 ⊕ Supplement Program: Lens/sensor configuration only based on order and price adder

	B016 Day	B016 Night	B036 Day	B036 Night	B041 Day	B041 Night	B061 Day	B061 Night	B079 Day	B079 Night	B119 Day	B119 Night	B237 Day	B237 Night	B500 Day	B500 Night	Vario Day	Vario Night	
Outdoor Dual Lens																			
Lens unit incl. sensor. D15 Fix, Pano and Pano Night models requires body and lens orders separately and self assembly																			
D15 Fix	--	⊕	⊕	⊕	⊕	⊕	⊕	⊕	⊕	⊕	⊕	⊕	⊕	⊕	⊕	⊕	⊕	⊕	Two parallel aligned sensors
D15 Pano	--	--	⊕	--	⊕	--	* Pano = For a 180° Dual Panorama Image there are 2 lens units required: B041 (Day/Day or Night/Night combination)												
D15 Pano Night	--	--	--	⊕	⊕	--													
D15 Day/Night	--	⊕ & ⊕	⊕ & ⊕	⊕ & ⊕	⊕ & ⊕	⊕ & ⊕	⊕ & ⊕	⊕ & ⊕	⊕ & ⊕	⊕ & ⊕	⊕ & ⊕	⊕ & ⊕	⊕ & ⊕	⊕ & ⊕	--	--	--	--	
D15 Body	--	🌿	🌿	🌿	🌿	🌿	🌿	🌿	🌿	🌿	🌿	🌿	🌿	🌿	🌿	🌿	--	--	
M15	--	⊕ & ⊕	⊕ & ⊕	● & ●	⊕ & ⊕	⊕ & ⊕	● & ●	⊕ & ⊕	● & ●	⊕ & ⊕	⊕ & ⊕	⊕ & ⊕	⊕ & ⊕	⊕ & ⊕	--	--	--	--	
M15 Body	🌿	🌿	🌿	🌿	🌿	🌿	🌿	🌿	🌿	🌿	🌿	🌿	🌿	🌿	🌿	🌿	🌿	🌿	
S15 Set 1	●	-	-	-	-	-	-	-	-	-	-	-	-	-	-	-	-	-	
S15 Set 2	● & ●	-	-	-	-	-	-	-	-	-	-	-	-	-	-	-	-	-	
S15 Set 3	● & ●	-	-	-	-	-	-	-	-	-	-	-	-	-	-	-	-	-	
S15 Body	🌿	🌿	🌿	🌿	🌿	🌿	🌿	🌿	🌿	🌿	🌿	🌿	🌿	🌿	🌿	🌿	🌿	🌿	
V15	-	-	-	-	⊕	⊕	-	-	⊕	⊕	-	-	-	-	-	-	-	-	
V15	-	-	-	-	⊕	⊕	-	-	⊕	⊕	-	-	-	-	-	-	-	-	

Thermal		L43	L65	L135
Thermal TR		B079	B119	B237
Image Angle (horizontal)				
M15 Thermal	An additional optical sensor module can be combined (see above M15 Body)	⊕	⊕	⊕
M15 Thermal TR		⊕	⊕	⊕
S15 Thermal	The second sensor input can be equipped with a thermal or optical sensor module (see S15 Body) or as S15 PTMount Thermal/PTMount	⊕	⊕	⊕
S15 Thermal TR		⊕	⊕	⊕
PTMount Thermal		⊕	⊕	⊕
PTMount TR		⊕	⊕	⊕

🌿 Available standard lenses/sensor modules/camera bodies for self assembly, to be ordered separately
 -- Lens or sensor combination not available

PLEASE NOTE – Special Export Regulations for Thermographic Cameras

Cameras with thermographic image sensors ('thermographic cameras') are subject to special U.S. and ITAR (International Traffic in Arms Regulation) export regulations:

According to the currently valid export regulations of the U.S. and ITAR, cameras with thermographic image sensors or their component parts cannot be exported to countries that have been embargoed by the U.S./ITAR. This currently applies

to Syria, Iran, Cuba, North Korea and Sudan, in particular. The equivalent delivery ban also applies to all individuals and institutions included in 'The Denied Persons List' (see www.bis.doc.gov, under Policy Guidance > Lists of Parties of Concern).

These cameras and their installed thermographic image sensors are not to be used for the design, development, or production of nuclear, biological or chemical weapons or installed in these systems.



Decentralized Architecture Increases Reliability and Reduces System Costs

Since 2000, MOBOTIX IP cameras have been known for their high-quality video performance and low bandwidth consumption thanks to their **"decentralized architecture"**. The cameras themselves execute video analysis & event detection **internally**, and manage their video ring buffer on a NAS or server by

themselves. This reduces the workload of the VMS workstation and network dramatically. Network fluctuations or longer interruptions are compensated by an onboard video buffer (SD card). As a result, MOBOTIX video systems are very reliable and need fewer servers, fewer workstations and less network infrastructure than other brands. This reduces the overall system costs as well as power consumption and the total energy bill. Encrypted recording by the camera itself guarantees data security and privacy.



Standalone System incl. Network Recording

- SD ring buffer
- NAS ring buffer
- Video sensor
- Recording
- Video analysis
- Alarms

Inventor of 360° Hemispheric IP Cameras

In 2008, MOBOTIX invented the 360° hemispheric camera technology. Compared to other brands, hemispheric processing is done onboard to increase image quality and to reduce network bandwidth. The 180° panoramic view

with onboard image correction delivers realistic impressions of the scene with sharp details at the lowest possible bandwidth.

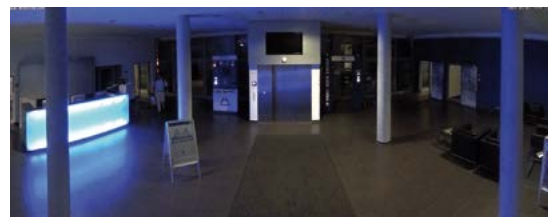
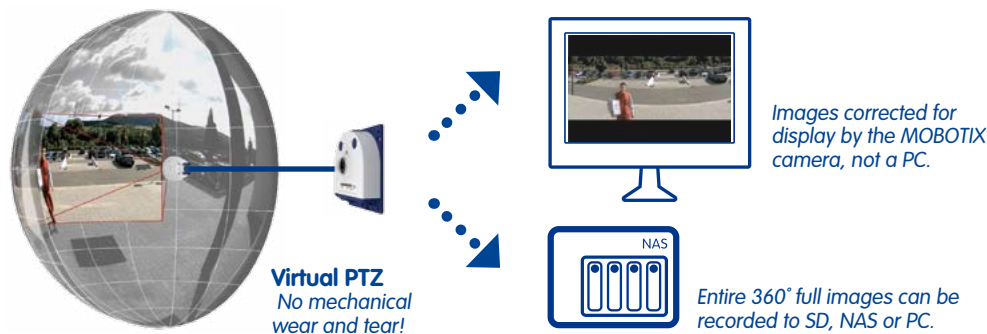

Four virtual PTZ cameras out of a single 360° hemispheric camera

Decentralized IP Cameras are More Intelligent Than Standard IP Cameras

- Intelligent processing
- Recording management
- Video Management System
- Integrated image analysis and sensors

What the Experts Say

"A camera from MOBOTIX contains a total video surveillance system within itself, including built-in DVR software, microphone, speaker, motion detection sensor, temperature sensor. Such product innovations have provided MOBOTIX with a significant competitive advantage, positioning it to grow strongly in the future."

Archana Rao, Video Market Research Analyst, Frost & Sullivan



Highest Quality – Made in Germany

Great imaging starts with great technology. For many security specialists, our innovative history is legendary and the reason they continue to choose MOBOTIX. Each and every product is carefully constructed using the most advanced optical, electronic and manufacturing technologies. We use only the

highest-quality CMOS sensors and develop image processing software, which enables our cameras to produce exceptionally sharp, clean images. The MOBOTIX devices are continually perfected in our laboratories in Germany.



Each camera is tested at extreme temperatures before shipping.

MxPEG – The Optimized Video Codec for Security

Since 2003, MOBOTIX has used MxPEG, which is a video codec especially developed for security applications to ensure the validation of the recorded images. MxPEG is open, freely available and integrated in all main third-party

professional VMS of the market. In contrast to H.264, it also offers the shortest reaction time between scene and screen and supports video resolutions of up to 6 megapixel and higher.

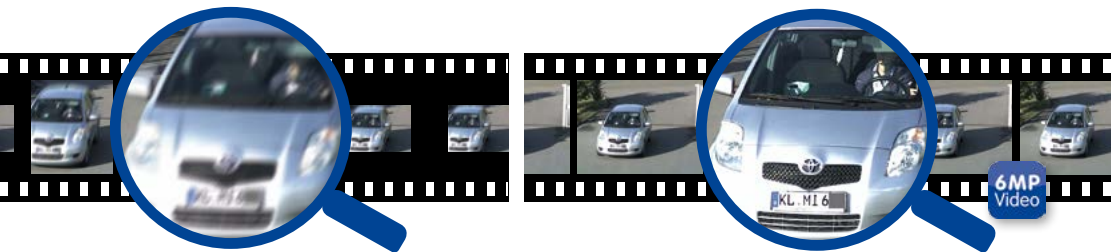

6MP Moonlight Technology

The MOBOTIX 6MP cameras have an outstanding increase of light sensitivity of more than 100-times than the former 3MP cameras. The monochrome version reaches even a 300-times higher sensitivity than the previous series. Instead of one second of exposure time the 6MP systems can select only 1/100 s, which results in capturing even fast moving objects in low light conditions.



Night image (< 0.5 lux) of a MOBOTIX camera.

In security every single frame of a video recording has to be as sharp as possible. For moving objects short exposure time is the key. Unfortunately short exposure time of 1/100 s grabs 10-times less light than 1/10 s. Especially in low light conditions, the lens, the image sensor and the image processing have to be very sophisticated to generate sharp images of the moving object.

In dark scenes long exposure times of up to one second create bright images and visible

static objects. This is perfect to acknowledge objects in darkness. But if objects are moving, long exposure times will create blurring, and make verification nearly impossible. In security applications moving objects are of utmost importance, therefore short exposure times are essential. Some brands are using a combination of technologies (for example Lightfinder, HDR, etc.). However, with this adding and overlaying of subsequent frames, small details could be suppressed, which is not acceptable in security applications.

This huge increase in light sensitivity was achieved by several means: wider sensor with bigger pixels, hardware noise reduction, new sophisticated lens with better light transmission, and an improved image processing reducing noise of low light images. This is called the new MOBOTIX Moonlight Technology because it enables the camera to generate color video of moving objects even in low light scenarios like moonlight.

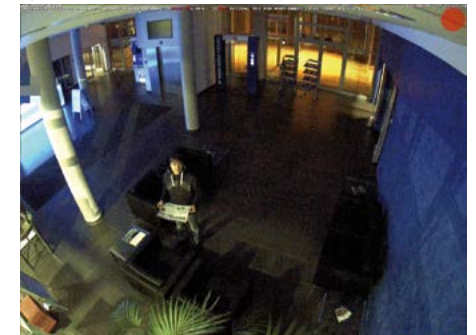

Night image (< 0.7 lux) of a MOBOTIX indoor camera.

Why Light Sensitivity Is So Important

One of the most important features that determines the quality of a security camera is its light sensitivity. A high light sensitivity allows for short exposure times, thus reducing motion blurring. This makes it easier to evaluate security-relevant footage, making details visible without the need for additional, expensive illumination.

“At MOBOTIX we strive to develop IP cameras that produce the highest possible image quality, which is much more important than ‘highest resolution’. By combining a 6MP image sensor with MxLEO, our new low light image enhancing technology, the new MOBOTIX hardware platform is now unrivaled for high-resolution lowlight image capture and zooming.”

Dr. Ralf Hinkel, MOBOTIX Founder



1 High-Resolution Digital Image Quality
6MP sensor and image processing inside the camera generate perfect images. More than twice as many pixels as Full HD. Increased resolution reduces amount of cameras required.

2 Decentralized Concept
Every camera is a complete surveillance system with all features integrated. Up to 10 times more cameras per server compared to central VMS-based systems. Lowest bandwidth and storage.

3 No Storage Limit
Each camera is able to manage its own terabyte-sized storage device (NAS) via the network. No additional management server needed.

4 HD Audio and SIP Technology
Every camera is using SIP standard for two-way communication including video, lip-synchronous audio (live & recording), remote camera control and automatic alarm calls.

5 Unlimited Scalability
Flexibility gives highest Return on Investment. Cameras and storage can be added, even while the system is in use; image format, frame rate and recording parameters are camera specific.

6 High Quality • Made in Germany
Robust and practically maintenance-free. Fiberglass-reinforced composite housing with built-in cable protection. No mechanically moving parts (no auto iris) to increase product lifetime.

7 Dual Camera Concept • Day and Night
Dual cameras with two sensors and digital switching between day and night, with brilliant color and best light-sensitive B&W sensor. Maintenance free without mechanical components.

8 Sun and Backlight Compensation
High-quality CMOS sensor without auto iris, software-driven contrast enhancement and configurable exposure zones guarantee optimum exposure control and longest product lifetime.

9 Weatherproof
Weatherproof design allows the camera to be installed anywhere without additional housings or climate systems to reduce power consumption and increase flexibility.

10 Efficient Video Codec • MxPEG
The MOBOTIX codec captures highest image quality and sharpness with full details on every still frame. The only video codec for security applications with shortest latency from scene to screen.

11 Simultaneous Recording, Event Search & Live Viewing
Each camera can handle live viewing for multiple users, recording and event search from anywhere in the world via network connection. Full image recording is independent from the live view.

12 Lowest Energy Consumption
Lowest energy bill saves up to 80 % due to low-power design. Each camera uses ca. 4-5 watts with no heating/cooling required, enables year-round standard PoE with one centralized UPS.

13 Bandwidth Management for Optimized Remote Access
Camera is recording high resolution without any loss of details and is able to manage frame rate and image size depending on the available bandwidth. Quality search over mobile networks.

14 MOBOTIX Ring Buffer Concept
MOBOTIX invented local longterm ring buffer recording in 2000. Synchronization (cloud principle) between internal (RAM, SD Card) and external storage (NAS). No network required during recording.

15 Bridging of Recordings During Network Failures • MxFFS
Local gigabyte recording with automatic archiving to external file server with terabyte capacity – no management software required. No lost events, robust against network failures.

16 Hemispheric Technology • 180° Panorama View
Secure an entire room without blind spots and virtual PTZ. All dewarping and panorama correction is managed inside the Hemispheric camera – no additional computer or software required.

17 Counting & Behavioral Analysis • MxAnalytics
MxAnalytics, inside the camera and free of charge, counts objects or generates behavioral events like turns, exceeding speed and more. Perfect tool to combine security and marketing needs.

18 Dual Camera • Intelligent Combination
The most advanced security camera solution combining thermal, optical and MxActivitySensor. Motion detection in complete darkness of up to 400 meters, supports privacy zones.

19 Game Changer in Motion Detection • MxActivitySensor
Most reliable detection of motion of objects with reduction of false alarms of up to 90 %. Inside the camera without any network required. No configuration time, license fees or extra costs.

20 Professional Video Management • MxMC
Highly intuitive and easy to learn without limits, for any operation systems and type of projects. 100 % included in the portfolio without extra costs. Highest cost saver for end users.



CMOS

Complementary metal-oxide semiconductor (CMOS) sensors efficiently transform light into electrons to facilitate image capturing. To further enhance lighting sensitivity and hence image quality, MOBOTIX has launched a new 1/1.8" 6-megapixel CMOS image sensor with moonlight technology.

DVR

A Digital Video Recorder typically consists of a Windows PC with licensed video management system (VMS) installed. MOBOTIX cameras do not require a DVR, since the VMS is already installed in the cameras.

IK rating

Indicates the degree of resistance against impact. MOBOTIX cameras with the appropriate vandalism sets have the highest impact rating of IK10 or better.

IP camera

Network-based camera that is using the Internet Transfer Protocol (TCP/IP) to establish video, audio and data connections.

IP rating

Ingress Protection is given as a two digit classification, which indicates the level of protection against water and dust. Most MOBOTIX devices are weatherproof rated at IP65 or IP66. The first digit classifies protection against foreign objects (6 – dustproof), the second digit classifies protection against water (5 – protected against water jets from any angle, 6 – protected against strong water jets from any angle).

MxBus

MxBus is a fully encrypted, two-wire bus system that connects and powers MOBOTIX devices over a distance of up to 50 m for building automation and camera-driven control systems. When adding an MxBus device, it gets a secured key that encrypts the entire communication.

MxPEG

MxPEG is the only codec specifically designed for video surveillance systems. The encoding capabilities of MxPEG by far exceed that of H.264 for capturing and recording movement in varying lighting conditions.

NAS

Network Attached Storage is a computer that is dedicated to file sharing only and thus more stable than Windows-based PCs. Generally Linux-based.

PoE/PoE+

Power over Ethernet is a standard for transferring both data and power via an Ethernet cable.

All MOBOTIX cameras are PoE-enabled and can be powered using a standard (IEEE 802.3af/at) PoE network switch.

PTZ

Pan, Tilt, Zoom usually refers to the mechanical movement of the camera. vPTZ refers to the digital movement and zooming within the camera's field of view. MOBOTIX cameras have no moving parts, and thus use virtual Pan, Tilt, Zoom (vPTZ).

RFID

Radio-Frequency Identification (RFID) is the wireless non-contact use of radio-frequency electromagnetic fields to transfer data, for the purposes of automatically identifying objects such as swipe cards to allow door access, for example.

SD/microSD card

Data is recorded on the factory-installed 4GB microSD card built into the camera, for example, on an NAS; the camera buffers the data on the internal SD card when the connection is severed and automatically synchronizes it at a later time.

SIP

The Session Initiation Protocol is a network protocol that is used to establish and control connections via computer networks. SIP is used for phone calls and for audio/video connections to and from MOBOTIX cameras.

Supplement Program

Camera models according to the Supplement Program. Production might start only after incoming orders. This might cause longer lead times and MOQs (Minimum Order Quantities). As an alternative, most of the Supplement Program models can also be easily assembled as combination of standard components (camera body plus sensor module or lens).

VMS

Video Management System provide data monitoring, image analysis and recording management. The system intelligence and logic resides in the VMS. MOBOTIX cameras are VMS-enabled.

VoIP

A Voice-over-IP device can initiate and carry phone calls over an IP data network. All MOBOTIX video devices are VoIP-enabled.

WiFi

This standard (sometimes also referred to as Wireless LAN or WLAN) allows IP devices to connect to the Internet or communicate with one another without Ethernet cabling.



MOBOTIX, the MX Logo, MxControlCenter, MxEasy, MxPEG and MxActivitySensor are trademarks of MOBOTIX AG registered in the European Union, the U.S.A. and in other countries.



Apple, Mac, the Apple logo, iPod and iTunes are Apple Inc. trademarks registered in the U.S.A. and other countries. iPhone, iPad, iPad mini and iPod touch are Apple Inc. trademarks.



General Notes: For a complete product overview and a current price list, see the MOBOTIX website • Sold only to distributors or commercial clients • Prices excluding VAT/sales tax • Manufacturer's recommended retail price ex-factory Langmeil, Germany • Subject to change without notice • MOBOTIX do not assume any liability for technical or editorial errors or omissions contained herein • All rights reserved • © MOBOTIX AG 2016



Proven Track Record in Large Scale Projects for Years

Lexington School
1,200 MOBOTIX Cameras, U.S.A.



Donbass Arena, UEFA EURO 2012 European Soccer Championship
528 MOBOTIX Cameras, Ukraine



DEPOT Logistics Center
66 MOBOTIX Cameras, Germany



Barwa Commercial Avenue
1,840 MOBOTIX Cameras, Qatar



Tyger Valley Shopping Centre
48 MOBOTIX Cameras, South Africa



Druzhba Arena, Hockey Stadium
600 MOBOTIX Cameras, Ukraine



Bergen County Jail
820 MOBOTIX Cameras, U.S.A.



Vatican Apostolic Library
70 MOBOTIX Cameras, Vatican City



ODS Optical Service GmbH
264 MOBOTIX Cameras, Germany



Multistrada Tire Manufacturer
134 MOBOTIX Cameras, Indonesia



S. Florida Water Management District
147 MOBOTIX Cameras, U.S.A.



City of Ghent Parking Authority
300 MOBOTIX Cameras, Belgium



Panama Ports Company
54 MOBOTIX Cameras, Panama



Valley Health Hospital
100+ MOBOTIX Cameras, U.S.A.



City of Dillingham, Traffic Security
80 MOBOTIX Cameras, U.S.A.



Icelandic Road Traffic Directorate
256 MOBOTIX Cameras, Iceland



Panorama Towers
137 MOBOTIX Cameras, U.S.A.



Republic Polytechnic
1,000 MOBOTIX Cameras, Singapore



Interislander Ferries
30 MOBOTIX Cameras, New Zealand



Calgary School
200 MOBOTIX Cameras, Canada

See also: www.mobotix.com > References



EN_08/2016

Professional Video Solutions

6MP Moonlight • VMS • Dual Thermal • IP Access Control • Analytics

