

V1

## Enbeam Fibre Product Guide

Excel is a world-class premium performing end-to-end infrastructure solution - designed, manufactured, supported and delivered - without compromise.

[www.excel-networking.com](http://www.excel-networking.com)

**excel**  
without compromise.

# excel

without compromise.

Excel is a world-class premium performance end-to-end infrastructure solution - designed, manufactured, supported and delivered - without compromise.

Excel is driven by a team of industry experts based in the UK, ensuring the latest innovation and manufacturing capabilities are implemented to surpass industry standards for quality and performance, technical compliance and ease of installation and use.

With an emphasis on compatibility and standards compliance 'from cable to rack', reliability and product availability, Excel is the complete trusted solution. Since the brand was launched to the UK market in 1997, Excel has enjoyed formidable growth and is sold in over 70 countries Worldwide. Excel has offices in Birmingham, St Neots and City of London in the UK and in Dubai in the United Arab Emirates.

The meteoric rise of the brand reflects a growing demand throughout the world for a reliable, standards-compliant, readily available, structured cabling and racking system. Excel is able to deliver this mix through a growing base of distributors and integrators across the region, which combine to make the brand an increasingly viable option.

With a focus on system performance, independent verification and a 25 year product and application warranty, when installed by an Excel Partner, it's easy to see why this is the system of choice in many government, education, retail, finance and enterprise installations.

This catalogue provides a complete overview of the Excel fibre optic range, for details on the complete Excel range please visit [www.excel-networking.com](http://www.excel-networking.com)

Please be aware that not all products are available in every country, so please check with your local provider to check availability.

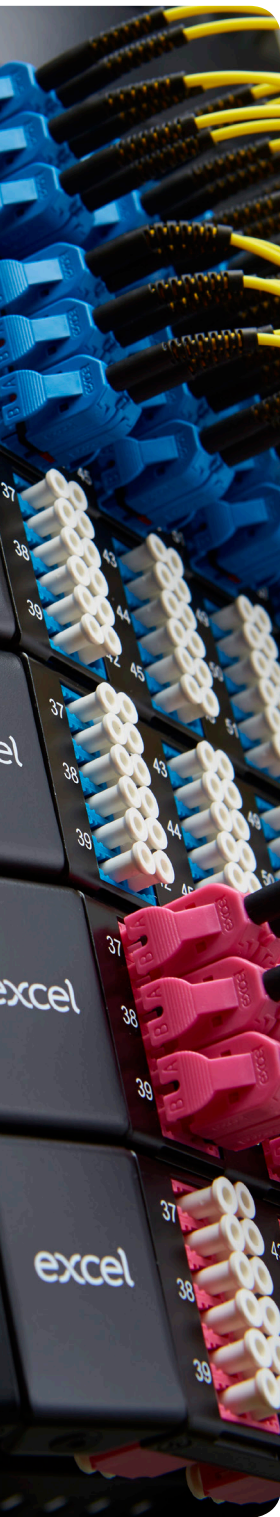

## The Excel Range

The Excel range is extensive - this catalogue is dedicated to the fibre optic range.

Listed below are the other product ranges that are currently available from Excel. Please visit [www.excel-networking.com](http://www.excel-networking.com) for full details.

### Copper Structured Cabling Systems



### Fibre Optic Cabling Systems



### PON - Passive Optical Networks



### Blown Fibre Cabling Systems



### Environ Network Racks, Wall Racks & Open Frames



### Residential/SoHo Cabling Systems



### Voice Cabling Systems

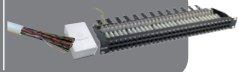

### Accessories & Testers



Whilst every attempt has been made to show exact photos of the products available within this catalogue, please note that sometimes only the style of the product is depicted.

# Multimode & Singlemode

Fibre optic cabling can be split into two families – Multimode and Singlemode. ‘Mode’ means path, so the light travels down multi and single paths respectively. Multimode can use the less expensive LED and VCSEL light sources to transmit the signal. This is referred to as ‘overfilled’ as the source is broad and floods the modes (and some of the cladding, hence overfilled). The core is manufactured with a graded index. This means that the central light path is ‘slower’ than the outer paths, which drastically reduces modal dispersion which is one of the limiting factors for the performance of multimode.

Singlemode requires a laser to transmit the signal along a single path. Lasers offer a high powered signal that can be transmitted for greater distances. However, the active equipment is a higher price than that of multimode.

## Multimode Fibre

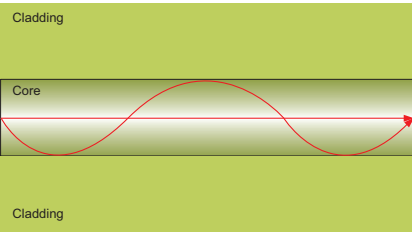

## Singlemode Fibre

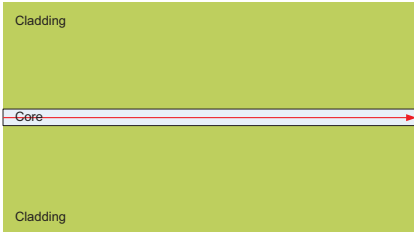

The fibre core comprises of a core and a cladding. This cladding is then covered by a primary coating.

The core is the medium that the light is transmitted along. The cladding is part of the manufacture of the glass. Typically, the cladding is of a consistent size for multimode and singlemode; namely 125µm. Likewise, the primary coating is usually 250µm for both multimode and singlemode. The primary coating can be coloured to differentiate between the cores within a cable.

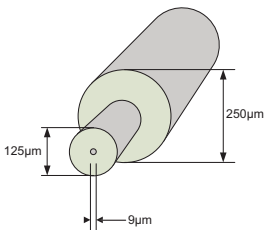
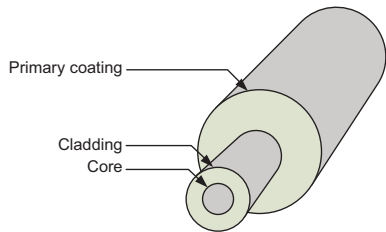

**Singlemode**  
**OS1 & OS2**

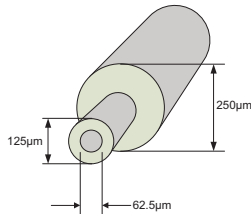

**Multimode**  
**OM1**

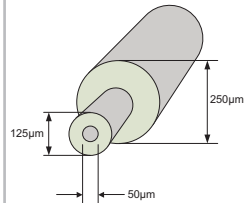

**Multimode**  
**OM2, OM3, OM4 & OM5**

# CPR Construction Products Regulation



The CPR (Construction Products Regulation) has been around for over 15 years and the inclusion of communications cables - both Copper and Fibre - came into force on the 1st of July 2016.

All products supplied by Excel into the EU market since 1st July 2017 are CPR compliant. We demonstrate this through certificates known as Declarations of Performance (DOPs) (available on the Excel website, through labelling on product packaging, printing in the legend on the outer sheath of the cable jackets, or by the product being placed on the market prior to this date. A product's Euroclass also appears on all Excel Networking specification sheets and in forthcoming editions of the product catalogue, along with sub-classifications for smoke development (s), flaming droplets (d) and acidity (a).

## The impact of BS6701:A1

BS6701:2016+A1:2017 states that the minimum Euroclass for telecommunications cable within scope of CPR shall be Cca s1b d2 a2. Excel products meet or exceed the minimum requirements defined within BS6701:2016+A1:2017.

## Excel Explains...

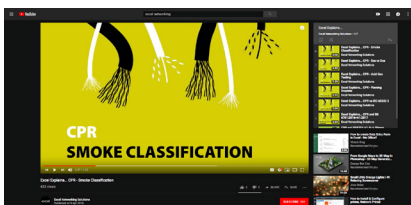

Take a look at our Youtube Channel ([www.youtube.com/excelnetworking](http://www.youtube.com/excelnetworking)) to view our first series of Excel Explains webinars, where we delve into the finer details of the Construction Products Regulation and the BS6701:A1.

Euroclass (ca)	Classification Criteria	Additional Criteria	Attestation of conformity system
<b>A</b>	EN ISO 1716 Gross heat of combustion		
<b>B1</b>	EN 50399 Heat release Flame spread	Smoke production (s1a, s1b, s2, s3) EN50399/EN61034-2	1+ Initial type-testing and continuous surveillance with audit testing of samples by 3rd party certification body factory production control (FPC) by manufacturer
<b>B2</b>		Acidity (a1, a2, a3) EN 50267-2-3	
<b>C</b>		EN 50575 Flame propagation	
<b>D</b>		Flaming droplets (d0, d1, d2) EN 50399	3 Initial type testing by 3rd party laboratory
<b>E</b>	EN 50575 Flame propagation		FPC by manufacturer
<b>F</b>			4 Initial type testing and FPC by manufacturer



# Excel Mounting Hardware - Fibre Adaptor Product Selector

**excel**  
without compromise.

		Module	
		Excel Enbeam Unloaded SC Simplex/LC Duplex Angled Module	Excel Enbeam Unloaded SC Duplex/LC Quad Angled Module
		P/N 200-438	P/N 200-439
			
Faceplate			
Excel Single Gang Bevelled Faceplate <u>P/N</u> 100-712		✓	✓
Excel Single Gang Flat Faceplate <u>P/N</u> 100-714		✓	✓
Excel Double Gang Bevelled Faceplate <u>P/N</u> 100-716		✓	✓
Excel Double Gang Flat Faceplate <u>P/N</u> 100-718		✓	✓



## Enbeam Internal/External Grade Fibre Cable – OM1/OM2/OM3/OM4/OM5/OS2

The Excel range of internal/external grade of fibre cables are available from stock in a choice of loose tube and tight buffered designs. Excel has worked extensively to provide singlemode fibre cables performing to the OS2 Category in all constructions. OS2 optical fibres fully support all OS1 & OS2 applications and are fully compatible.

### Central Loose Tube Fibre

The cables are constructed around a silica gel filled tube containing up to 24 colour coded 250µm buffered 62.5/125µm or 50/125µm Multimode or 9/125µm Singlemode fibres. This tube is covered with 'e glass' and a flame retardant and low smoke halogen free, outer sheath.

### Tight Buffered Fibre

The cables are constructed from a number of 900µm buffered fibres which are colour coded. The outer sheath is both flame retardant and low smoke zero halogen. The design and construction of this range has resulted in a light, easy to install, cost effective cable.

### Features

- LSOH Black Sheath
- Duct Grade
- Cut to length service
- Sequentially Metre Marked
- Suitable for Internal & External Use
- 25 Year System Warranty Available

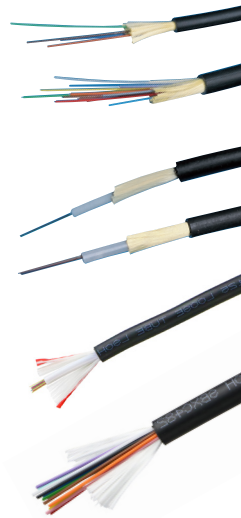

Loose Tube							
CPR-Rating	No. of cores	OM1	OM2	OM3	OM4	OM5	OS2
B2ca	4	290-047	290-049	290-150	294-004	-	295-300
	6	290-060	290-065	290-149	-	-	-
	8	290-067	290-069	290-151	294-008	-	295-301
	12	290-087	290-089	290-152	294-012	-	295-302
	16	290-081	290-090	290-153	294-016	-	295-303
	24	290-084	290-092	290-154	294-024	-	295-304
Cca	48	-	-	-	-	-	275-310
Dca	4	200-047	200-049	200-150	204-004	204-705	205-300
	6	200-060	200-065	200-149	204-006	-	-
	8	200-067	200-069	200-151	204-008	204-706	205-301
	12	200-087	200-089	200-152	204-012	204-707	205-302
	16	200-081	200-090	200-153	204-016	204-708	205-303
Eca	48	-	-	-	-	-	205-310
Fca	48	-	-	200-248	-	-	-

Tight Buffered							
CPR-Rating	No. of cores	OM1	OM2	OM3	OM4	OS2	
Cca	4	200-110	200-115	200-155	204-104	205-320	
	6	200-116	200-117	200-118	204-106	205-230	
	8	200-130	200-135	200-156	204-108	205-322	
	12	200-140	200-145	200-157	204-112	205-324	
	16	200-141	200-146	200-158	204-116	205-326	
	24	200-142	200-147	200-159	204-124	205-328	



For colours not shown please contact our sales team for minimum order quantities and lead time



## Enbeam Internal/External Grade CST Fibre Cable – OM1/OM2/OM3/OM4/OS2

### Loose Tube Fibre – Single Sheath Rodent Protected CST Armoured

Excel corrugated steel tape cables are available in OM1, 2, 3, 4 and OS2 specification. The loose tube containing up to 24 fibres is packed in aramid strength elements. The steel tape and blue low smoke zero halogen rodent protected sheath completes the design.



**RANGE  
EXTENDED**  
excel

Loose Tube CST						
CPR-Rating	No. of cores	OM1	OM2	OM3	OM4	OS2
B2ca	24	-	-	-	-	295-309
Cca	4	275-270	275-275	275-280	274-204	275-305
	6	-	-	-	-	-
	8	275-271	275-276	275-281	274-208	270-306
	12	275-272	275-277	275-282	274-212	275-307
	16	275-274	275-278	275-283	274-216	275-308
Eca	24	-	275-279	275-284	274-224	275-309
	4	-	205-275	205-280	204-204	205-305
	6	-	-	-	-	-
	8	-	-	205-281	204-208	200-306
	12	-	-	205-282	204-212	205-307
	16	-	-	205-283	204-216	205-308
	24	-	-	205-284	204-224	205-309

*Singlemode - Please note that all Excel loose tube singlemode cable designs ship as OS2 compliant specification and are backward compatible with OS1 specification and components.*

**MORE  
CORES?**  
excel

Call our Sales Office for price and availability on core counts not shown

## Enbeam Internal/External Grade SWA Fibre Cable – OM1/OM2/OM3/OM4/OS2

### Loose Tube Fibre – Single Sheath Rodent Protected SWA Armoured

The Excel range steel wire armoured cables are suitable for direct burial and the most demanding of installations. Available in OM1, OM2, OM3, OM4 and OS2 from stock these cables are constructed from standard single loose tube cables which are then packed into a flexible but strong fiberglass, waterblocking strength member. An internal sheath of Black Low Smoke Zero Halogen material is then applied, a rip cord is inserted under this sheath to ease cable stripping. Lengths of steel wire armouring are then applied and an oversheath of Black Low Smoke Zero Halogen is added. The cables shown in the table below are available from stock, if you require core counts or jacket colours not shown please call our sales office for availability details.



Loose Tube SWA						
CPR-Rating	No. of cores	OM1	OM2	OM3	OM4	OS2
	4	205-340	205-348	-	-	205-356
	6	-	-	-	-	-
Eca	8	205-342	205-364	-	-	205-368
	12	205-344	205-352	-	-	205-360
	16	205-346	205-366	-	-	205-370
	24	205-372	205-354	-	-	205-362



## Excelerator Pre-Terminated Distribution Cables

Excelerator pre terminated distribution cables are constructed from customer defined multi core 900 micron, tight buffered distribution cable.

Standard options available are designed to meet most requirements and include choices of multimode and singlemode, core counts and connector style's.

Typically cables are terminated on both ends; the 'fan out' assembly will be staggered in groups of cores at 50mm intervals.

Unless specified otherwise the longest fan out will measure 1 metre from the gland assembly to tip of connector. The fan outs are protected by means of a transparent protection tube to which a ring style pulling eye is fixed to the pulling end of the cable assembly.

Unless requested all cables lengths are measured from tip to tip of connectors, where fan outs are staggered, this length is measured from longest fan out to longest fan out.

Assemblies are generally supplied with matched connectors at ends A and B, however Excel can supply mixed connector styles for example LC to SC if required.

Each cable is fitted with strain relief cable glands so that they may be fitted directly to the rear of an Excel Fibre Optic Patch Panels. A generic cable identification label is affixed to each end of the assembly 50 mm from the gland; customer specific labelling schemes can be applied on request.

Excelerator Pre-Terminated Distribution cables are extremely robust, yet compact and flexible in design. This together with the range of core counts, and connectivity available make them ideal for use as link from inside a patch panel to inside a patch panel, inside panel to consolidation points, or rack to rack links.

Also available in LT, CST and SWA - contact your local sales office for further details.

### Features

- 8 core to 48 core
- 900 Micron Fanout Construction
- Multimode and Singlemode
- SC and LC connectivity
- LS0H outer sheath as standard
- Supplied with protective tube and pulling eye
- Alternative core counts, connectivity and sheath colours on request
- 25 Year System Warranty Available

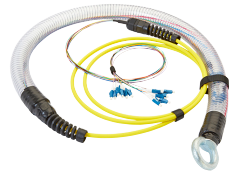

Visit the online configurator at  
[excelerator.excel-networking.com](https://www.excelerator.excel-networking.com)  
to build your cable.

## Excelerator Pre-Terminated Break-out Cables



Excelerator pre terminated Break-out cables are constructed from customer defined 2mm Tight Buffered multi core fibre cable.

Standard cable assemblies are designed to offer a high degree of flexibility through available features and options and include choices of multimode and singlemode, core counts and connector style's allowing each cable to be manufactured to fit the exact application.

Typically cables are terminated on both ends via a 'fan out' assembly. Unless specified otherwise the fan out will measure 1 metre from the heatshrink to tip of connector. When delivered the fan outs are protected by means of a black mesh braid formed to include a ring style pulling eye at the pulling end of the cable assembly.

Unless requested all cables lengths are measured from tip to tip of connectors.

Assemblies are generally supplied with matched connectors at ends A and B, however Excel can supply mixed connector styles for example LC to SC if required.

A generic identification label is affixed to each end of the assembly 50 mm from the heatshrink; customer specific labelling schemes can be applied on request.

Excelerator Pre-Terminated Break-out cables are extremely robust, yet compact and flexible in design. This together with the range of core counts, and connectivity available make them ideal for use in direct patching applications from panel to switch blade, panel to server, or switch to server.

### Features

- 8 core to 48 core
- 2.0mm Fanout Construction
- Multimode and Singlemode
- SC or LC connectivity
- LSOH outer sheath as standard
- Supplied with protective mesh sleeve
- Alternative core counts, connectivity and sheath colours on request
- 25 Year System Warranty Available

Visit the online configurator at  
[excelerator.excel-networking.com](https://excelerator.excel-networking.com)  
to build your cable.

## Excelerator Pre-Terminated Mini Break-out Cables

Excelerator pre terminated Break-out cables are constructed from customer defined 2mm Tight Buffered multi core fibre cable.

Standard cable assemblies are designed to offer a high degree of flexibility through available features and options and include choices of multimode and singlemode, core counts and connector style's allowing each cable to be manufactured to fit the exact application.

Typically cables are terminated on both ends with matched connectors at ends A and B, however Excel can supply mixed connector styles for example LC to SC if required.

As standard the length of each fan out for all core counts between 8 and 48 core cables is 1 metre +/- 50mm, whether 2.0mm diameter tight buffered cable or 900 micron tubes.

The 900 micron tubes are staggered in groups of 6 or 12 cores to aid with dressing within the fibre panels with the distance between each group being 35mm. They are protected by means of a transparent protection tube to which a ring style pulling eye is fixed to one end of the cable assembly. 2.0mm fan outs are constructed to the same length.

Unless requested all cables lengths are measured from tip to tip of connectors, where fan outs are staggered, this length is measured from longest fan out core to the longest fan out core.

Each cable is fitted with strain relief cable glands so that they may be fitted directly to the rear of an Excel Fibre Optic Patch Panels. A generic cable identification label is affixed to each end of the assembly 50 mm from the gland; customer specific labelling schemes can be applied on request.

Excelerator Pre-Terminated Mini Break-out cables are extremely compact, lightweight and robust. This together with the range of core counts, and connectivity available make them ideal for use as links from patch panel to equipment, patch panel to patch panel, patch panel to consolidation points, and rack to rack links.

### Features

- 8 core to 48 core
- 2.0mm or 900 Micron Fanout Construction
- Multimode and Singlemode
- SC or LC connectivity
- Supplied with protective tube or sleeve if fanout is 900 micron
- Alternative core counts, connectivity and sheath colours on request
- LS0H outer sheath as standard
- 25 Year System Warranty Available



Visit the online configurator at  
[excelerator.excel-networking.com](https://www.excelerator.excel-networking.com)  
to build your cable.



## Enbeam LC Uniboot Patch Cords



Excel's Enbeam range of LC Uniboot patch cords provide excellent performance in a compact design, using 2mm round cable containing 2 x 600 micron diameter fibres, which are ideal in high density applications. These patch cords are available in two versions – standard uniboot and pull-tab version. Both versions allow for easy polarity changing.

### Features

- LC Duplex Uniboot
- Easy polarity change
- Available in a choice of OM3, OM4 or OS2 bend-insensitive fibre
- 2mm diameter cable
- Low loss – excellent performance
- 25 Year System Warranty Available
- High Density

Length (Metres)	OM3	OM4	OS2
0.5	203-400	204-400	202-400
1	203-401	204-401	202-401
2	203-402	204-402	202-402
3	203-403	204-403	202-403
5	203-405	204-405	202-405
10	203-410	204-410	202-410
15	203-415	204-415	202-415
20	203-420	204-420	202-420

## Enbeam Fibre Optic Patch Cords – Multimode 50/125µm OM4

Enbeam OM4 50/125µm duplex patch leads are manufactured from the highest quality 900µm buffer/jacket optical fibre, terminated with ceramic ferrule connectors. Each cable has strain relief boots to prolong and maintain performance levels of the assembly, transmit and receive ‘legs’ of each duplex cable are identified by means of a ring type cable marker, fixed to each end of the assembly. A short distance from these identification rings heat shrink is applied to maintain an easy to manage bonded two fibre cable. Finally a label containing a unique batch number is fixed to the centre of the cable for quality and traceability purposes.

### Features

- Choice of connectors available
- Factory terminated under ISO9001 quality control procedures
- Batch Number Tracking
- Individually tested (test certificate included with each cable)
- Individually bagged and labelled
- 25 Year System Warranty Available



Length (Metre)	Heather Violet			Aqua		
	SC-SC Duplex	LC-LC Duplex	LC-SC Duplex	SC-SC Duplex	LC-LC Duplex	LC-SC Duplex
1	204-338	204-330	204-334	204-308	204-300	204-304
2	204-339	204-331	204-335	204-310	204-301	204-305
3	204-340	204-332	204-336	-	204-302	204-306
5	204-341	204-333	204-337	-	204-303	204-307
10	-	204-352	-	-	204-323	-

## Enbeam Fibre Optic Patch Cords – Multimode 50/125µm OM3 – Aqua

The Enbeam range of patch cords are constructed from high quality connectors and 50/125µm OM3 grade cable. Each cable has a short strain relief boot and is supplied with a test report detailing insertion loss. All of the patch cords come with an LSOH aqua sheath and are individually bagged and labelled.



Length (Metre)	ST-ST Duplex	SC-SC Duplex	ST-SC Duplex	LC-LC Duplex	LC-SC Duplex	LC-ST Duplex
1	200-001	200-005	200-013	200-043	200-054	200-062
2	200-002	200-006	200-014	200-044	200-055	200-063
3	200-003	200-007	200-015	200-046	200-056	200-064
5	200-004	200-008	200-016	200-048	200-057	200-070
10	-	200-009	200-017	200-050	200-058	200-071
15	-	200-011	200-018	200-052	200-059	200-073
20	-	200-012	200-019	200-053	200-061	200-075
30	-	-	-	202-176	-	-

## Enbeam Fibre Optic Patch Cords – Multimode 50/125µm OM2 – Orange

The Enbeam range of patch cords are constructed from high quality connectors and 50/125µm OM2 grade cable. Each cable has a short strain relief boot and is supplied with a test report detailing insertion loss. All of the patch cords come with an LSOH orange sheath and are individually bagged and labelled.

- 2.8mm Outside Diameter



Length (Metre)	ST-ST Duplex	SC-SC Duplex	ST-SC Duplex
0.5	202-197	202-191	-
1	200-200	200-224	200-216
2	200-202	200-226	200-218
3	200-204	200-228	200-220
5	200-206	200-229	200-222
10	200-209	200-236	200-227
15	200-286	200-237	200-219
20	200-287	200-238	-
30	202-200	202-194	-



Length (Metre)	LC-LC Duplex	LC-SC Duplex	LC-ST Duplex
0.5	202-171	202-178	202-184
1	200-168	200-172	200-176
2	200-169	200-173	200-177
3	200-170	200-174	200-178
5	200-171	200-175	200-179
10	200-265	200-093	200-180
15	200-266	200-094	-
20	200-267	200-095	200-533
30	202-174	202-181	202-187

**SOMETHING DIFFERENT?**  
excel

For cables not shown, call our sales team. We offer a fast turnaround service for different coloured cables, connector types and lengths

## Enbeam Fibre Optic Patch Cords – Multimode 62.5/125µm OM1 – Grey

The Enbeam range of patch cords are constructed from high quality connectors and 62.5/125µm OM1 grade cable. Each cable has a short strain relief boot and is supplied with a test report detailing insertion loss. All of the patch cords come with an LSOH grey sheath and are individually bagged and labelled.

- 2.8mm Outside Diameter



Length (Metre)	ST-ST Duplex	SC-SC Duplex	ST-SC Duplex
0.5	202-196	202-190	-
1	200-290	200-500	200-600
2	200-300	200-510	200-610
3	200-310	200-520	200-620
5	200-320	200-530	200-630
10	200-324	200-524	200-634
15	200-326	200-525	200-635
20	200-329	200-526	200-636
30	202-199	202-193	-



Length (Metre)	LC-LC Duplex	LC-SC Duplex	LC-ST Duplex
0.5	202-170	202-177	202-183
1	200-181	200-185	200-189
2	200-182	200-186	200-190
3	200-183	200-187	200-191
5	200-184	200-188	200-192
10	202-000	202-003	202-006
15	202-001	202-004	202-007
20	202-002	-	202-008
30	202-173	202-180	202-186

## Enbeam Fibre Optic Patch Cords – Singlemode 9/125µm OS2

The Enbeam range of patch cords are constructed from high quality connectors and 9/125µm OS2 grade cable. Each cable has a short strain relief boot and is supplied with a test report detailing insertion loss. All of the patch cords come with an LS0H yellow sheath and are individually bagged and labelled.



Length (Metre)	ST/UPC-ST/UPC Duplex	SC/UPC-SC/UPC Duplex	ST/UPC-SC/UPC Duplex	LC/UPC-LC/UPC Duplex
0.5	202-198	202-192	-	202-172
1	200-251	200-261	200-255	200-678
2	200-252	200-262	200-256	200-680
3	200-253	200-263	200-257	200-682
5	200-254	200-264	200-259	200-684
10	200-107	200-102	200-268	200-201
15	200-108	200-103	200-105	200-203
20	200-109	200-104	200-106	200-205
30	202-201	202-195	-	202-175



Length (Metre)	LC/UPC-SC/UPC Duplex	LC/UPC-ST/UPC Duplex	FC/UPC-FC/UPC Duplex
0.5	202-179	202-185	-
1	200-686	200-694	200-501
2	200-688	200-696	200-502
3	200-690	200-698	200-503
5	200-692	200-699	200-504
10	200-098	200-099	200-505
15	200-097	200-100	-
20	200-096	200-101	-
30	202-182	202-188	-



Length (Metre)	SC/APC - SC/APC Duplex	SC/APC - SC/UPC Duplex	SC/APC - LC/UPC Duplex
1	201-001	201-021	201-041
2	201-002	201-022	201-042
3	201-003	201-023	201-043
5	201-005	201-025	201-045
10	201-010	201-030	-



## Enbeam Fibre Patch Cords – Singlemode 9/125µm OS2 - G657

The Enbeam range of patch cords are constructed from high quality connectors and G657 bend insensitive 9/125µm OS2 grade cable. Each cable has a short strain relief boot and is supplied with a test report detailing insertion loss. All of the patch cords come with a blue outer sheath and are individually bagged and labelled.

### Features

- G657 Bend Insensitive Fibre
- Blue Outer Sheath
- 2.0mm cable



Length (metre)	SC-SC Duplex	LC-SC Duplex	LC-LC Duplex	SC-SC Simplex	LC-SC Simplex	SC-SC (APC) Simplex	SC/APC-SC/APC Simplex
1	200-953	200-958	200-963	200-968	200-973	200-978	201-211
2	200-954	200-959	200-964	200-969	200-974	200-979	201-212
3	200-955	200-960	200-965	200-970	200-975	200-980	201-213
5	200-956	200-961	200-966	200-971	200-976	200-981	201-214
10	200-957	200-962	200-967	200-972	200-977	200-982	-

## Enbeam Pigtaills – 50/125µm OM2/OM3/OM4 & 9/125µm OS2

The Enbeam range of pigtaills are constructed from high quality connectors and 50/125µm OM2, 50/125µm OM3, 50/125µm OM4 and 9/125µm OS2 grade cables. Each cable has a short strain relief boot and is supplied with a test report detailing insertion loss.

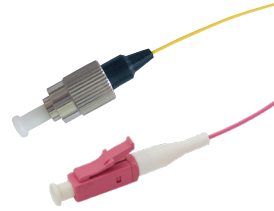

Pigtail Type	OM1	OM2	OM3	OM4	OS2
ST	200-556	200-557	200-577	-	200-576
SC	200-552	200-553	200-555	204-351	200-554
LC	200-558	200-559	200-560	204-350	200-561
FC	-	-	-	-	200-563
SC/APC	-	-	-	-	200-562



## Enbeam LC Pigtail 12 Colour Packs

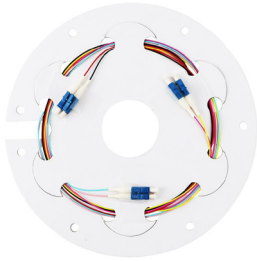

Excel multimode fibre optic pigtails are manufactured from the highest quality 900 micron optical fibre, terminated with ceramic ferrule connectors of various types. To assist in fast cable preparation and splicing semi tight buffered, easy strip, cable is used as standard. Cable preparation, termination and testing is carried out to strictly managed procedures in an Excel approved, ISO9001 registered manufacturing facility. Each pigtail has a strain relief boot to prolong and maintain performance levels of the assembly. A short distance from the connector a label containing a unique batch number is fixed to cable for quality and traceability purposes.

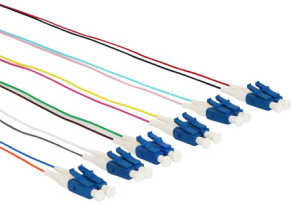

### Features

- Packaged on a cardboard reel
- Colours as defined with TIA 598 (Blue, Orange, Green, Brown, Slate, White, Red, Black, Yellow, Violet, Rose & Aqua)
- Choice of lengths
- Choice of connectors
- Each cable is individually bagged and labelled
- Test Certificate with each cable
- RoHS Compliant



Length (m)	OM3 LC Pigtail 50/125	OM4 LC Pigtail 50/125	OS2 LC Pigtail 9/125
0.5m - 12 Colour Pack	200-578	204-322	200-565
1m - 12 Colour Pack	200-546	200-547	200-548
2m - 12 Colour Pack	200-603	200-604	200-602

## Enbeam Fibre Optic Connectors – ST, SC, LC and FC

The STII and SC single piece connectors are designed for quick and easy termination either on-site or in the factory. Suitable for use with both loose tube and tight buffered cable, can be used with the cold cure termination system detailed in this section.

Strain relief boots are included, yellow for singlemode and black for multimode. By using the Excel SC Duplex Clip, two SC Simplex Connectors can be joined to form a single SC Duplex Connector.

The LC Connector is becoming the Small Form Factor (SFF) of choice. Occupying half the space of a duplex SC Connector, this product is ideal for high density applications such as Data Centres and Server Farms.

The FC connectors are designed for quick and easy termination either on-site or in the factory. Suitable for use with both loose tube and tight buffered cable, can be used with the cold cure termination system detailed in this section.

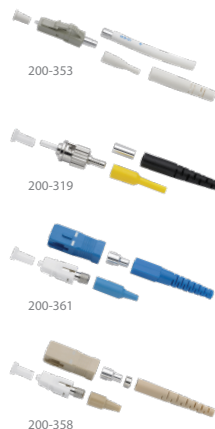

### Features

- Individually bagged
- Highest quality ceramic ferrule
- Both 900µm pigtail and 2 or 3mm cable boots included
- Simplex and Duplex options in SC and LC
- 25 Year System Warranty Available
- Choice of category & colour

ST Connectors	Part Number
ST II Simplex Connector, Singlemode	200-319
ST II Simplex Connector, Multimode	200-330
ST II Simplex Connector, Multimode (Pack of 100)	200-330-100
SC Connectors	
SC Simplex Connector, Singlemode - Blue	200-361
SC Simplex Connector, Multimode - Beige	200-358
SC Simplex Connector, Multimode - Beige (Pack of 100)	200-358-100
SC Simplex Connector, Multimode - Aqua	200-358-AQ
SC Simplex Connector, Multimode – Heather Violet	200-358-VT
LC Simplex Connectors	
LC Simplex Connector, Singlemode - Blue	200-351
LC Simplex Connector, Multimode - Beige	200-353
LC Simplex Connector, Multimode - Beige (Pack of 100)	200-353-100
LC Simplex Connector, Multimode - Aqua	200-353-AQ
LC Simplex Connector, Multimode – Heather Violet	200-353-VT



For further details please see the next page



### LC Duplex Connector

LC Duplex Connector, Singlemode - Blue	200-349
LC Duplex Connector, Multimode - Beige	200-352
LC Duplex Connector, Multimode - Aqua	200-352-AQ
LC Duplex Connector, Multimode - Heather Violet	200-352-VT

### FC Simplex Connector

FC Simplex Connector, Singlemode	200-302
FC Simplex Connector, Multimode	200-301

### SC Duplex Clip

	Part Number
SC Duplex Clip - Beige	200-367
SC Duplex Clip - Blue	200-367-BL
SC Duplex Clip - Aqua	200-367-AQ
SC Duplex Clip - Heather Violet	200-367-VT

## Enbeam Fibre Optic Adaptors – ST and SC



### ST-SC Adaptors

ST to SC Adaptors are used to match cables or assemblies with different connectors, can be used either in-line or mounted in patch panels or faceplates.



### ST-ST Adaptors

Standard construction ST in-lines available in either multimode or singlemode.

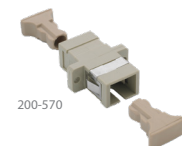

### SC Adaptors

SC adaptors, available in both Simplex and Duplex, can be mounted in panels or wall plates and are suitable for use with both Simplex and Duplex SC connectors. In an extension to the range, Angled Polish (APC) style are now also available.

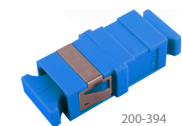

ST-SC Adaptors	Part Number
ST-SC Duplex Adaptor	200-735
ST-ST Adaptors	
ST Standard Adaptor, Locknut and Black ID Ring	200-350
ST Singlemode Bulkhead Adaptor	200-350-SM
SC Adaptors	
SC Simplex Adaptor, Multimode - Beige	200-570
SC Simplex Adaptor, Multimode - Violet	201-130
SC Duplex Adaptor, Multimode - Beige	200-365
SC Duplex Adaptor, Multimode - Violet	201-131
SC Simplex Adaptor, Singlemode - Blue	200-571
SC Duplex Adaptor, Singlemode - Blue	200-366
SC Simplex Adaptor, Multimode - Aqua	201-135
SC Duplex Adaptor, Multimode - Aqua	201-136
SC Flangeless Adaptors	
SC Duplex Flangeless Adaptor Multimode - Ivory*	200-370
SC Duplex Flangeless Adaptor Singlemode - Blue*	200-372
SC Duplex Flangeless Adaptor Multimode - Aqua*	201-140
SC Duplex Flangeless Adaptor Multimode - Violet*	201-139
SC Duplex Flangeless APC Singlemode Adaptor	200-375
SC Simplex Flangeless Multimode Adaptor	200-393
SC Simplex Flangeless Singlemode Adaptor	200-394
SC/APC Adaptors	
SC/APC Simplex Adaptor, Singlemode - Green	200-566
SC/APC Duplex Adaptor, Singlemode - Green	200-567
SC/APC Duplex Flangeless Adaptor	200-375

\* Use Flangeless SC Duplex and LC Quad adaptors when fitting into a sliding draw ball-bearing runner, Excel Enbeam Patch Panel.

## Enbeam Fibre Optic Adaptors – LC and FC

### LC Adaptors

The Excel LC adaptor is a polymer body through coupler with RJ45/SC Simplex footprint.

### FC Adaptors

FC Adaptors are used to match cables or assemblies with different connectors, can be used either in-line or mounted in patch panels or faceplates.

**Alignment Sleeve:** Multimode - Phosphor Bronze  
Singlemode - Ceramic (Zirconia)

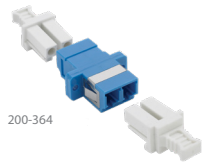

LC Adaptors	Part Number
LC Duplex Adaptor, Multimode	200-363
LC Duplex Adaptor, Multimode - Rose	201-132
LC Duplex Adaptor, Singlemode	200-364
LC Quad Adaptor, Multimode	200-568
LC Quad Adaptor, Multimode - Rose	201-133
LC Quad Adaptor, Singlemode	200-569
LC Duplex Adaptor, Multimode - Aqua	201-137
LC Quad Adaptor, Multimode - Aqua	201-138
LC Flangeless Adaptors	
LC Quad Flangeless Adaptor Multimode - Violet*	201-141
LC Duplex Flangeless Adaptor Singlemode	200-362
LC Duplex Flangeless APC Adaptor Singlemode	200-359
LC Quad Flangeless Adaptor Multimode*	200-579
LC Quad Flangeless Adaptor Singlemode*	200-580
LC Quad Flangeless Adaptor Multimode - Aqua*	201-142
LC Duplex Flangeless Adaptor Multimode	200-360
LC Duplex Flangeless APC Adaptor Singlemode	200-359
LC Duplex Flangeless Adaptor Singlemode	200-362
LC/APC Adaptors	
LC/APC Duplex Adaptor, Singlemode	200-364-LCAPC
FC Adaptors	
FC Multimode Adaptor	200-389
FC Singlemode Adaptor	200-390

**RANGE  
EXTENDED**  
excel

\* Use Flangeless SC Duplex and LC Quad adaptors when fitting into a sliding draw ball-bearing runner, Excel Enbeam Patch Panel.

## Enbeam Splice Management

The Enbeam Enhanced fibre splice holder, is a high quality plastic housing with an easy place / lift off lid. The unit is design for up to 24-way installations. The unit can be used in several applications and has a self-adhesive fixing pad on the base, making it perfect for both horizontal and vertical fitting.



### Features

- Dimensions: Width 87mm x Depth 40mm x Height 15mm
- Intended for use with 2mm x 45mm splice protectors. (part number 200-397)

Description	Part Number
Enbeam Enhanced Splice Holder	200-396
Enbeam 2mm x 45mm Splice Protector	200-397

## Enbeam Splice Bridge and Protector

A compact 12 way Splice Bridge which provides an effective means to store up to 12 Fusion Splice Protectors. Ideal for use in patch panels or wall enclosures. The bridge can be fixed to any flat clean surface using the self adhesive pads on the base.



Description	Part Number
Enbeam 12 Way Splice Bridge	200-391
Enbeam Splice Protectors (Clear) 3mm x 61mm	200-398
Enbeam Splice Protectors (Clear) 3mm x 45mm	200-399
Enbeam Splice Protectors (Clear) 2mm x 45mm	200-397



## Enbeam Splice Cassette



The Enbeam splice cassette offers excellent fibre management and protection for up to 24 fibres. Ideal for both primary and secondary-coated fibre. Holds up to 24no 3mm diameter splice protectors (either 61mm or 45mm long). Comes complete with clear lid, label and self-adhesive pads for secure location. These splice cassettes are also stackable and clip together with a hinge to allow easy access to the lower cassettes.

Description	Part Number
Enbeam 24 Fibre Splice Cassette with Lid	200-400

## Enbeam Splice Tray Conversion Kits



The Excel Enbeam splice tray conversion kit has been designed to allow the Environ 100-651 enclosure to be converted into a fibre optic splice enclosure by simply changing the internal fixing plate. With two options of kits available - 48 fibre (200-128) and 240 fibre (200-129) - the enclosure can be adapted to part-copper and part-fibre using the 200-128 or gives a full fibre option using the 200-129. Both kits can also be installed onto any back plate via the fixing holes. This also allows splice trays to be mounted in multiple applications and expanded as required.

### Features

- Leaf style cassette
- 12 fibres per tray
- Up to 240 fibres
- Side cable routing manager



Description	Part Number
Enbeam Splice Tray Conversion Kit – 48 Fibre	200-128
Enbeam Splice Tray Conversion Kit – 240 Fibre	200-129



## Excel ExpressNet Patch Panel Frames

The Excel ExpressNet Panel accepts either and/or both copper and fibre modules. The ability to have fibre and copper presented in one panel offers flexibility in the installation, reduces required rack space and provides future proofing in system design. Useful in the extremes of installations from data centres where the ExpressNet panel may aid separation of the routes of cabling, to a remote wall box that has a small number of fibre and copper links, the ExpressNet panel will suit any environment. The construction of the panel has a chrome colour finish and may be used for either screened or unscreened copper cabling and LC or MTP fibre connectivity.

A 4 or 8 module ExpressNet panel is available, both using 1U of rack space.

### Features

- 4 & 8 Module Capacity Patch Panel Frames
- 1U of Rack Space
- Accepts Copper & Fibre Modules
- Toolless assembly and module fitting

Description	Part Number
Excel 1U ExpressNet Patch Panel Frames - 4 Module - Unloaded	100-230
Excel 1U ExpressNet Patch Panel Frames - 8 Module - Unloaded	100-231
Excel 1U Blanks for ExpressNet Panel - Black - 5 Pack	100-232



## Enbeam 6 Port Duplex LC Fibre ExpressNet Module

Enbeam 6 Port Duplex (12 Fibre) LC Modules are available with Multimode and Singlemode adaptors. Manufactured from high impact flame retardant plastic the modules are fitted with LC duplex adaptors and an internal management wheel to store the slack fibre. The incoming cable is introduced to the module through a split rubber grommet and secured with a cable tie on the inside.

After termination the module is simply fitted to one of the compatible Excel ExpressNet Patch Panels permitting different categories of Fibre and Copper to be presented on the same panel without interference. The modules are easily fitted and removed from the rear of the patch panel by activating release latches.

### Features

- 6 Port Duplex LC (12 Fibre) Module
- 4 & 8 Module Patch Panels Frames
- OM3, OM4 & OS2 Versions
- Toolless assembly and patch panel fitting
- Compatible with Excel ExpressNet Panel
- 25 Year System Warranty Available
- Split grommet cable entry

Description	Part Number
Enbeam 6 Port (12 Fibre) OM3 LC ExpressNet Module	201-600
Enbeam 6 Port (12 Fibre) OM4 LC ExpressNet Module	201-601
Enbeam 6 Port (12 Fibre) OS2 LC ExpressNet Module	201-602





## Enbeam 6 Port Duplex MTP Fibre ExpressNet Module



Enbeam 6 Port Duplex (12 Fibre) MTP ExpressNet Modules are available with Multimode and Singlemode adaptors. Manufactured from high impact flame retardant plastic the modules are fitted with LC duplex adaptors to the front of the module and MTP to the rear, an internal management wheel stores the slack fibre.

After termination the module is simply fitted to one of the compatible Excel ExpressNet Patch Panels permitting different categories of Fibre and Copper to be presented on the same panel without interference.

The modules are easily fitted and removed from the rear of the patch panel by activating release latches.

### Features

- 6 Port Duplex MTP (12 Fibre) Module
- OM3, OM4 & OS2 Versions
- Compatible with Excel ExpressNet Panel
- MTP adaptor in rear of module
- 4 & 8 Module Patch Panels Frames
- Toolless assembly and patch panel fitting
- 25 Year System Warranty Available

Description	Part Number
Enbeam 6 Port Duplex (12 Fibre) OM3 LC to MTP ExpressNet Module	201-610
Enbeam 6 Port Duplex (12 Fibre) OM4 LC to MTP ExpressNet Module	201-611
Enbeam 6 Port Duplex (12 Fibre) OS2 LC to MTP ExpressNet Module	201-612

## Enbeam 4 Port MTP ExpressNet Module



The Excel 4 Port MTP ExpressNet modules are fitted with MTP adaptors and allow the incoming trunk cable to be presented into the module through the open back of the module and secured with a cable tie on the inside. After the trunk cables are connected, the module can be simply fitted to one of the compatible Excel ExpressNet Patch Panels permitting different categories of Fibre and Copper to be presented on the same panel without interference. The modules are easily fitted and removed from the rear of the patch panel by activating the release latches.

### Features

- 4 Port MTP coupler module
- Compatible with ExpressNet panel
- Allows up to 4 trunk cables



Description	Part Number
Enbeam 4 Port MTP ExpressNet Module - Singlemode	201-603
Enbeam 4 Port MTP ExpressNet Module - Multimode	201-604

## Enbeam Fibre Optic Patch Panels

Excel's Enbeam enhanced range of fibre optic patch panels offer many improvements, additional features and extended range options. The new sliding drawer features ball-bearing runners for smooth operation and rigidity. Finger pulls are included on the front panel.

The use of recessed, flangeless, adaptors creates increased space for port and panel labelling, and makes the panel facia more aesthetically pleasing. Also, new to the range is the optional patch cord management bar with hinged front plate for ease of access. Behind the front plate is a full width/full height labelling field. The management bar is easily attached and removed as required with 4 screws (provided).

The new range offers ST, SC and LC versions, both singlemode and multimode. The SC and LC multimode panels are available with beige, aqua or heather violet adaptors as required for OM1, OM2, OM3 and OM4 fibre types and Blue for OS2 connectivity

The LC versions have a maximum capacity of 96 fibres (24 quad adaptors). All panels are supplied with a fitting kit which includes mountings, cage nuts & screws, glands, cable ties and our new 24-way splice holder.

Further options include splice cassettes and pigtails pre-installed. The pigtails are supplied in 12 colours pre-loaded into cassettes according to TIA 598 colour code standard.

### Features

- Ball-bearing sliding drawer for smooth operation
- Recessed adaptors provide larger labelling field
- Optional patch cord management bar with additional labelling options
- Extended range – OS2, OM3 and OM4
- Blue (OS2), Aqua (OM3) and Violet (OM4) adaptors
- High quality zirconia ceramic alignment sleeves
- Options for pre-loaded splice cassettes
- Options for pre-loaded 12-colour pigtails
- Full installation kit included
- New 24-way splice holders included
- Ideal for splicing and pre-terminated cables
- Excel 25-year System Warranty Available

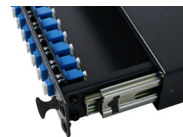
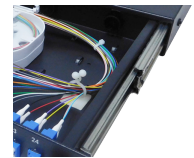

For further product details please see the next page



Description	Part Number	Colour	Adaptors	P/Tails	Cassettes
<b>ST Singlemode</b>					
Enbeam 24 Way SM Fibre Panel -4 ST 4F	200-427	N/A	4	0	0
Enbeam 24 Way SM Fibre Panel -8 ST 8F	200-428	N/A	8	0	0
Enbeam 24 Way SM Fibre Panel -12 ST 12F	200-429	N/A	12	0	0
Enbeam 24 Way SM Fibre Panel -16 ST 16F	200-430	N/A	16	0	0
Enbeam 24 Way SM Fibre Panel -24 ST 24F	200-431	N/A	24	0	0
<b>ST Multimode</b>					
Enbeam 24 Way MM Fibre Panel -4 ST 4F	200-377	N/A	4	0	0
Enbeam 24 Way MM Fibre Panel -8 ST 8F	200-378	N/A	8	0	0
Enbeam 24 Way MM Fibre Panel -12 ST 12F	200-379	N/A	12	0	0
Enbeam 24 Way MM Fibre Panel -16 ST 16F	200-382	N/A	16	0	0
Enbeam 24 Way MM Fibre Panel -24 ST 24F	200-384	N/A	24	0	0



Description	Part Number	Colour	Adaptors	P/Tails	Cassettes
<b>SC DX Singlemode OS2 - Colour Coded Adaptors</b>					
Enbeam 24 Way SM Fibre Panel -4 SC DX 8F	200-480	Blue	4	0	0
Enbeam 24 Way SM Fibre Panel -6 SC DX 12F	200-481	Blue	6	0	0
Enbeam 24 Way SM Fibre Panel -8 SC DX 16F	200-482	Blue	8	0	0
Enbeam 24 Way SM Fibre Panel -12 SC DX 24F	200-483	Blue	12	0	0
Enbeam 24 Way SM Fibre Panel -24 SC DX 48F	200-411	Blue	24	0	0
<b>SC DX Multimode - OM1/OM2</b>					
Enbeam 24 Way MM Fibre Panel -4 SC DX 8F	200-401	Beige	4	0	0
Enbeam 24 Way MM Fibre Panel -6 SC DX 12F	200-405	Beige	6	0	0
Enbeam 24 Way MM Fibre Panel -8 SC DX 16F	200-406	Beige	8	0	0
Enbeam 24 Way MM Fibre Panel -12 SC DX 24F	200-407	Beige	12	0	0
Enbeam 24 Way MM Fibre Panel -24 SC DX 48F	200-408	Beige	24	0	0
<b>SC DX OM3 - Colour Coded Adaptors</b>					
Enbeam 24 Way OM3 Fibre Panel -12 SC DX 24F	203-530	Aqua	12	0	0
Enbeam 24 Way OM3 Fibre Panel -24 SC DX 48F	203-532	Aqua	24	0	0

\* All products in the table above will only use an SC Duplex Flangeless adaptor.



Description	Part Number	Colour	Adaptors	P/Tails	Cassettes
-------------	-------------	--------	----------	---------	-----------

**SC DX OM4 - Colour Coded Adaptors**

Enbeam 24 Way OM4 Fibre Panel -12 SC DX 24F*	204-530	Violet	12	0	0
Enbeam 24 Way OM4 Fibre Panel -24 SC DX 48F*	204-532	Violet	24	0	0

**SC SX Singlemode - OS2**

Enbeam 24 Way SM Fibre Panel -12 SC SX 12F	200-484	Blue	12	0	0
Enbeam 24 Way SM Fibre Panel -24 SC SX 24F	200-485	Blue	24	0	0

**SC SX Multimode - OM1/OM2**

Enbeam 24 Way MM Fibre Panel -12 SC SX 12F	200-486	Beige	12	0	0
Enbeam 24 Way MM Fibre Panel -24 SC SX 24F	200-487	Beige	24	0	0

\* These products will only use an SC Duplex Flangeless adaptor.



Description	Part Number	Colour	Adaptors	P/Tails	Cassettes
-------------	-------------	--------	----------	---------	-----------

**LC DX & LC QD Singlemode OS2 - Colour Coded Adaptors**

Enbeam 24 Way SM Fibre Panel -4 LC DX 8F	200-470	Blue	4	0	0
Enbeam 24 Way SM Fibre Panel -8 LC DX 16F	200-472	Blue	8	0	0
Enbeam 24 Way SM Fibre Panel -12 LC DX 24F	200-474	Blue	12	0	0
Enbeam 24 Way SM Fibre Panel -24 LC DX 48F	200-476	Blue	24	0	0
Enbeam 24 Way SM Fibre Panel -24 LC QD 96F*	200-488	Blue	24	0	0

**LC DX & LC QD Multimode - OM1/OM2**

Enbeam 24 Way MM Fibre Panel -4 LC DX 8F	200-460	Beige	4	0	0
Enbeam 24 Way MM Fibre Panel -8 LC DX 6F	200-462	Beige	8	0	0
Enbeam 24 Way MM Fibre Panel -12 LC DX 24F	200-464	Beige	12	0	0
Enbeam 24 Way MM Fibre Panel -24 LC DX 48F	200-466	Beige	24	0	0
Enbeam 24 Way MM Fibre Panel -24 LC QD 96F*	200-489	Beige	24	0	0

**LC DX OS2 & OS2/APC - OS2 - Colour Coded Adaptors**

Enbeam 24 Way OS2 Fibre Panel -24 LC DX 48F+P/Tail&Cass	201-620	Blue	24	48	2
Enbeam 24 Way OS2 Fibre Panel 24 LC DX 48F+Cassette	201-624	Blue	24	0	2
Enbeam 24 Way OS2 Fibre Panel -24 LC APC DX 48F+P/Tail&Cass	201-621	Green	24	48	2
Enbeam 24 Way OS2 Fibre Panel 24 LC APC DX 48F+Cassette	201-625	Green	24	0	2

**LC DX OM3 - Colour Coded Adaptors**

Enbeam 24 Way OM3 Fibre Panel -24 LC DX 48F+P/Tail &Cass	201-622	Aqua	24	48	2
Enbeam 24 Way OM3 Fibre Panel 24 LC DX 48F+Cassette	201-626	Aqua	24	0	2
Enbeam 24 Way OM3 Fibre Panel -12 LC DX 24F	203-540	Aqua	12	0	0
Enbeam 24 Way OM3 Fibre Panel -24 LC DX 48F	203-542	Aqua	24	0	0
Enbeam 24 Way OM3 Fibre Panel -12 LC DX Shuttered 24F	203-550	Aqua	12	0	0
Enbeam 24 Way OM3 Fibre Panel - 24 LC DX Shuttered 48F	203-552	Aqua	24	0	0

\* These products will only use an LC Quad Flangeless adaptor.

For further product details please see the next page



Description	Part Number	Colour	Adaptors	P/Tails	Cassettes
<b>LC DX OM4 - Colour Coded Adaptors</b>					
Enbeam 24 Way OM4 Fibre Panel -24 LC DX 48F+P/Tail &Cass	201-623	Violet	24	48	2
Enbeam 24 Way OM4 Fibre Panel 24 LC DX 48F+Cassette	201-627	Violet	24	0	2
Enbeam 24 Way OM4 Fibre Panel -12 LC DX 24F	204-540	Violet	12	0	0
Enbeam 24 Way OM4 Fibre Panel -24 LC DX 48F	204-542	Violet	24	0	0
Enbeam 24 Way OM4 Fibre Panel -12 LC DX Shuttered 24F	204-550	Violet	12	0	0
Enbeam 24 Way OM4 Fibre Panel -24 LC DX Shuttered 48F	204-552	Violet	24	0	0



Description	Part Number	Colour	Adaptors	P/Tails	Cassettes
<b>Empty Panels</b>					
Enbeam 24 Way ST/FC SX Fibre Panel - Empty	200-950	N/A	N/A	0	0
Enbeam 24 Way SCDX/LCQD Fibre Panel -Empty*	200-951	N/A	N/A	0	0
Enbeam 24 Way SC SX/LC DX Fibre Panel -Empty	200-952	N/A	N/A	0	0

\* These products will only use an LC Quad or SC Duplex Flangeless adaptor.

## Enbeam Patch Cord Manager



Enbeam optional patch cord management bar with hinged front plate for ease of access. Behind the front plate is a full width/full height labelling field. This management bar is easily attached and removed as required with 4 xrews (provided).

Description	Part Number
Excel 1U Front Management bar with label holder - Black	203-525

## Enbeam Splitter Panels

The Excel Enbeam 3U (14 Modules) and 1U (3 Modules) Splitter Panels have been designed to fit 19" rack mounting profiles and house Excel splitter modules. Their decreased depth of 120mm allows the units to be installed into Environ Enclosures or the Environ 19" Communications Rack.

### Features

- 19" rack mountable
- Holds 3/14 modules
- Option of 1U & 3U rack space
- Compact design

Description	Part Number
Enbeam LGX 1U 3 Module Panel	208-028
Enbeam LGX 3U 14 Module Panel	208-029
Compatible PLC Splitters	
Enbeam 1 X 8 SC APC LGX PLC Splitter	208-912
Enbeam 1 X 16 SC APC LGX PLC Splitter <i>Fits 3U Chassis only</i>	208-913



## Enbeam 32-Way Splitter Panel

The Excel Enbeam 32-way SC APC Splitter Panels are sliding drawer "tray-style" housings suitable to be installed into 1U of rack space. Outgoing SC APC adaptors are presented from right to left and numbered from 1 to 32 with the incoming port to the right of the panel. The PLC Splitter is then housed inside the panel in an ABS housing to protect it against accidental damage.

### Features

- Port identification numbers
- Sliding drawer on ball bearing runners
- 1U rack space design
- Recessed adaptors
- 25 Year System Warranty

Description	Part Number
Enbeam 1 X 32 SC APC Splitter Panel	208-918





## Open Ended and Boxed PLC Splitters



The Enbeam PLC (Planar Lightwave Circuit) Splitter is fabricated using silica optical waveguide technology. Its compact size, high reliability, wide operating wavelength and good channel-to-channel uniformity is widely used in PON applications.

Excel provides whole series of 1xN splitter products that are tailored for specific applications. All products meet GR-1209-CORE and GR-1221-CORE requirements.

### Features

- Compact design
- Low insertion loss
- Operating wavelength from 1260nm to 1650nm



Description		Part Number
Enbeam 1 X 4 Open Ended PLC Splitter	Excel's Open-Ended PLC	208-901
Enbeam 1 X 8 Open Ended PLC Splitter	Splitters are not connectorized at either end and can be terminated on application.	208-902
Enbeam 1 X 16 Open Ended PLC Splitter		208-903
Enbeam 1 X 32 Open Ended PLC Splitter		208-904
Enbeam 1 X 4 SC APC Boxed PLC Splitter	Excel's Boxed PLC Splitters are fully connectorized and housed, as a plug-and-play solution.	208-906
Enbeam 1 X 8 SC APC Boxed PLC Splitter		208-907
Enbeam 1 X 16 SC APC Boxed PLC Splitter		208-908
Enbeam 1 X 32 SC APC Boxed PLC Splitter		208-909



## Enbeam Fibre Panel – 1U 12-cassette High Density

The Enbeam 1U 19" HD panel provides an expandable and innovative cassette based patching solution. The panel offers a capacity of 12 cassettes, each containing 12 fibres, with either LC or MTP presentation. A variety of cassettes are offered providing a highly flexible system and all cassettes can be mixed and matched as required.

Options include LC splice cassettes, LC-MTP cassettes and MTP pass-through panels (offering up to 576 fibres in 1U). LC cassettes are offered with singlemode (blue), OM3 (aqua) or OM4 (violet) adaptors. The cassettes can be spliced or pre-terminated.

The panel also offers full and innovative patch cord management to the front and cable management to the rear.

### Features

- 1U 19" High Density – 144 Fibre Capacity
- Variety of cassette options
- LC & MTP cassette options
- Pre-termination options
- Flexible patch lead and cable management
- 25 Year System Warranty available

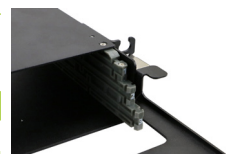

Description	Part Number
Enbeam 1U 144C HD Cassette Fibre Optic Panel	208-100

### Related Product Information

Description	Part Number
Enbeam HD 6P-12F-LC-OS2 Cassette with adaptors	208-105
Enbeam HD 6P-12F-LC-OM3 Cassette with adaptors	208-106
Enbeam HD 6P-12F-LC-OM4 Cassette with adaptors	208-107
Enbeam HD 6P-12F-LC-OS2 Cassette with adaptors & pigtails	208-108
Enbeam HD 6P-12F-LC-OM3 Cassette with adaptors & pigtails	208-109
Enbeam HD 6P-12F-LC-OM4 Cassette with adaptors & pigtails	208-110
Enbeam HD 6P-12F LC-MTP OS2 Cassette – loaded (standard)	208-111
Enbeam HD 6P-12F LC-MTP OS2 Cassette – loaded (MOD 1)	208-111-MOD1
Enbeam HD 6P-12F LC-MTP OS2 Cassette – loaded (MOD2)	208-111-MOD2
Enbeam HD 6P-12F LC-MTP OM3 Cassette – loaded (standard)	208-112
Enbeam HD 6P-12F LC-MTP OM3 Cassette – loaded (MOD 1)	208-112-MOD1
Enbeam HD 6P-12F LC-MTP OM3 Cassette – loaded (MOD2)	208-112-MOD2
Enbeam HD 6P-12F LC-MTP OM4 Cassette – loaded (standard)	208-113
Enbeam HD 6P-12F LC-MTP OM4 Cassette – loaded (MOD 1)	208-113-MOD1
Enbeam HD 6P-12F LC-MTP OM4 Cassette – loaded (MOD2)	208-113-MOD2
Enbeam HD 4P MTP Coupler Cassette – Aligned Key - Multimode	208-114
Enbeam Magnetic Patch Cord Manager (6pcs)	208-115
Enbeam HD 4P MTP Coupler Cassette – Key-Up/Key-Down - Singlemode	208-116
Enbeam Magnetic Splice Protectors (PK100)	208-117



# Enbeam Fibre Panel - Cross Reference Chart



## Style of Adaptor

ST		FC		SC smp			APC	SCDX			APC		
200-350	200-350-SM	200-389	200-390	200-570	201-130	200-571	201-135	200-566	200-365	201-131	200-366	201-136	200-567



## Type of panel

ST	200-427		✓	✓	✓	✓							
	200-428		✓	✓	✓	✓							
	200-429		✓	✓	✓	✓							
	200-430		✓	✓	✓	✓							
	200-431		✓	✓	✓	✓							
	200-377		✓	✓	✓	✓							
	200-378		✓	✓	✓	✓							
	200-379		✓	✓	✓	✓							
	200-382		✓	✓	✓	✓							
	200-384		✓	✓	✓	✓							
200-950		✓	✓	✓	✓								
SC	200-480												
	200-481												
	200-482												
	200-483												
	200-411												
	200-401												
	200-405												
	200-406												
	200-407												
	200-408												
LC	203-530												
	203-532												
	204-530												
	204-532												
	200-484					✓	✓	✓	✓	✓			
	200-485					✓	✓	✓	✓	✓			
	200-486					✓	✓	✓	✓	✓			
	200-487					✓	✓	✓	✓	✓			
	200-951					✓	✓	✓	✓	✓			
	200-952					✓	✓	✓	✓	✓			
LC	200-470					✓	✓	✓	✓	✓			
	200-472					✓	✓	✓	✓	✓			
	200-474					✓	✓	✓	✓	✓			
	200-476					✓	✓	✓	✓	✓			
	200-488					✓	✓	✓	✓	✓			
	200-460					✓	✓	✓	✓	✓			
	200-462					✓	✓	✓	✓	✓			
	200-464					✓	✓	✓	✓	✓			
	200-466					✓	✓	✓	✓	✓			
	200-489					✓	✓	✓	✓	✓			
	201-620					✓	✓	✓	✓	✓			
	201-624					✓	✓	✓	✓	✓			
	201-621					✓	✓	✓	✓	✓			
	201-625					✓	✓	✓	✓	✓			
	201-622					✓	✓	✓	✓	✓			
	201-626					✓	✓	✓	✓	✓			
	203-540					✓	✓	✓	✓	✓			
	203-542					✓	✓	✓	✓	✓			
	203-550					✓	✓	✓	✓	✓			
	201-623					✓	✓	✓	✓	✓			
201-627					✓	✓	✓	✓	✓				
204-540					✓	✓	✓	✓	✓				
204-542					✓	✓	✓	✓	✓				
204-550					✓	✓	✓	✓	✓				
204-552					✓	✓	✓	✓	✓				
200-952					✓	✓	✓	✓	✓				





## Enbeam High Density LC-MTP HD 6-Port Cassette

The Enbeam LC-MTP High-Density cassette is designed for the Enbeam HD 1U panel, which has a capacity for 12 cassettes, offering up to 144 fibres per 1U. A range of cassettes are offered and can be mixed and matched as required to offer a highly dense and flexible system for both LC and MTP connectivity.

The LC – MTP cassettes come complete with LC Adaptors at the front and MTP couplers at the rear, with an MTP-LC fan-out fibre assembly installed & factory tested. The cassettes are available in OS2 (Angled MTP), OM3 and OM4, configured standard or MOD 1 or MOD2. See the part number table below for all options.

The cassettes can be inserted into the panel from the front or the rear and feature 2 physical stops, one installed and one for patching.

The panel also offers full and innovative patch cord management to the front and cable management to the rear.

### Features

- High Density 6-port LC-MTP cassette
- MTP – US-Conec Elite connectors
- OS2 MTP – Angled
- Standard, MOD1 and MOD2 versions
- Part of the Enbeam HD panel system
- OS2, OM3 and OM4 options
- 25 Year System Warranty available

Description	Part Number
Enbeam HD 6P-12F LC-MTP OS2 Cassette – loaded (standard)	208-111
Enbeam HD 6P-12F LC-MTP OS2 Cassette – loaded (MOD 1)	208-111-MOD1
Enbeam HD 6P-12F LC-MTP OS2 Cassette – loaded (MOD2)	208-111-MOD2
Enbeam HD 6P-12F LC-MTP OM3 Cassette – loaded (standard)	208-112
Enbeam HD 6P-12F LC-MTP OM3 Cassette – loaded (MOD 1)	208-112-MOD1
Enbeam HD 6P-12F LC-MTP OM3 Cassette – loaded (MOD2)	208-112-MOD2
Enbeam HD 6P-12F LC-MTP OM4 Cassette – loaded (standard)	208-113
Enbeam HD 6P-12F LC-MTP OM4 Cassette – loaded (MOD 1)	208-113-MOD1
Enbeam HD 6P-12F LC-MTP OM4 Cassette – loaded (MOD2)	208-113-MOD2

### Related Product Information

Description	Part Number
Enbeam 1U 144C HD Cassette Fibre Optic Patch Panel	208-100
Enbeam HD 6P-12F-LC-OS2 Cassette with adaptors	208-105
Enbeam HD 6P-12F-LC-OM3 Cassette with adaptors	208-106
Enbeam HD 6P-12F-LC-OM4 Cassette with adaptors	208-107
Enbeam HD 6P-12F-LC-OS2 Cassette with adaptors & pigtails	208-108
Enbeam HD 6P-12F-LC-OM3 Cassette with adaptors & pigtails	208-109
Enbeam HD 6P-12F-LC-OM4 Cassette with adaptors & pigtails	208-110
Enbeam HD 4P MTP Coupler Cassette – Aligned Key - Multimode	208-114
Enbeam Magnetic Patch Cord Manager (6pcs)	208-115
Enbeam HD 4P MTP Coupler Cassette – Key-Up/Key-Down - Singlemode	208-116
Enbeam Magnetic Splice Protectors (PK100)	208-117

## Enbeam High Density LC HD 6-Port Cassette

The Enbeam LC High-Density cassette is designed for the Enbeam HD 1U panel, which has a capacity for 12 cassettes, offering up to 144 fibres per 1U. A range of cassettes are offered and can be mixed and matched as required to offer a highly dense and flexible system for both LC and MTP connectivity.

The LC cassettes can be spliced (12 magnetic splice protectors are included), direct terminated or pre-terminated offering a truly plug-n-play solution. The cassettes can be supplied with or without pigtails. See the part number table below for all options. The pigtails (if supplied) are 12-colours and loaded to TIA 598 colour standard.

The cassettes can be inserted into the panel from the front or the rear and feature 2 physical stops, one installed and one for patching.

The panel also offers full and innovative patch cord management to the front and cable management to the rear.

### Features

- High Density 6-port LC cassette
- Complete with splice protectors
- Can be spliced or direct terminated
- Pre-termination options
- Part of the Enbeam HD panel system
- OS2, OM3 and OM4 options
- 25 Year System Warranty Available



Description	Part Number
Enbeam HD 6P-12F-LC-OS2 Cassette with adaptors	208-105
Enbeam HD 6P-12F-LC-OM3 Cassette with adaptors	208-106
Enbeam HD 6P-12F-LC-OM4 Cassette with adaptors	208-107
Enbeam HD 6P-12F-LC-OS2 Cassette with adaptors & pigtails	208-108
Enbeam HD 6P-12F-LC-OM3 Cassette with adaptors & pigtails	208-109
Enbeam HD 6P-12F-LC-OM4 Cassette with adaptors & pigtails	208-110

### Related Product Information

Description	Part Number
Enbeam 1U 144C HD Cassette Fibre Optic Patch Panel	208-100
Enbeam HD 6P-12F LC-MTP OS2 Cassette – loaded (standard)	208-111
Enbeam HD 6P-12F LC-MTP OS2 Cassette – loaded (MOD 1)	208-111-MOD1
Enbeam HD 6P-12F LC-MTP OS2 Cassette – loaded (MOD2)	208-111-MOD2
Enbeam HD 6P-12F LC-MTP OM3 Cassette – loaded (standard)	208-112
Enbeam HD 6P-12F LC-MTP OM3 Cassette – loaded (MOD 1)	208-112-MOD1
Enbeam HD 6P-12F LC-MTP OM3 Cassette – loaded (MOD2)	208-112-MOD2
Enbeam HD 6P-12F LC-MTP OM4 Cassette – loaded (standard)	208-113
Enbeam HD 6P-12F LC-MTP OM4 Cassette – loaded (MOD 1)	208-113-MOD1
Enbeam HD 6P-12F LC-MTP OM4 Cassette – loaded (MOD2)	208-113-MOD2
Enbeam HD 4P MTP Coupler Cassette – Aligned Key - Multimode	208-114
Enbeam Magnetic Patch Cord Manager (6pcs)	208-115
Enbeam HD 4P MTP Coupler Cassette – Key-Up/Key-Down - Singlemode	208-116
Enbeam Magnetic Splice Protectors (PK100)	208-117



## Enbeam High Density MTP HD 4-Port Module



The Enbeam MTP High-Density 4-Port through-coupler module is designed for the Enbeam HD 1U panel, which has a capacity for 12 modules, offering up to 576 fibres per 1U (12-way MTP) or 1152 fibres per 1U (24-way MTP).

The MTP Modules can be mixed and matched with other cassettes within the range to offer a highly flexible patching solution.

Two versions are available – The Multimode version features Aligned-Key adaptors, whilst the Singlemode version supports angled MTP and offers Key-Up/Key-Down Adaptors.

The Modules can be inserted into the panel from the front or the rear and feature 2 physical stops, one installed and one for patching.

The panel also offers full and innovative patch cord management to the front and cable management to the rear.

### Features

- High Density 4-port MTP Coupler Module
- Houses 4 MTP Couplers
- Key-Aligned and Key-Up/Key-Down Adaptor options
- Density up to 576 fibres in 1U when fully loaded
- Up to 1152 fibres in 1U with 24-fibre MTP's
- Part of the Enbeam HD panel system
- 25 Year System Warranty Available
- US Conec adaptor

Description	Part Number
Enbeam HD 4P MTP Coupler Cassette – Aligned Key - Multimode	208-114
Enbeam HD 4P MTP Coupler Cassette – Key-Up/Key-Down - Singlemode	208-116

### Related Product Information

Description	Part Number
Enbeam 1U 144C HD Cassette Fibre Optic Patch Panel	208-100
Enbeam HD 6P-12F-LC-OS2 Cassette with adaptors	208-105
Enbeam HD 6P-12F-LC-OM3 Cassette with adaptors	208-106
Enbeam HD 6P-12F-LC-OM4 Cassette with adaptors	208-107
Enbeam HD 6P-12F-LC-OS2 Cassette with adaptors & pigtails	208-108
Enbeam HD 6P-12F-LC-OM3 Cassette with adaptors & pigtails	208-109
Enbeam HD 6P-12F-LC-OM4 Cassette with adaptors & pigtails	208-110
Enbeam HD 6P-12F LC-MTP OS2 Cassette – loaded (standard)	208-111
Enbeam HD 6P-12F LC-MTP OS2 Cassette – loaded (MOD 1)	208-111-MOD1
Enbeam HD 6P-12F LC-MTP OS2 Cassette – loaded (MOD2)	208-111-MOD2
Enbeam HD 6P-12F LC-MTP OM3 Cassette – loaded (standard)	208-112
Enbeam HD 6P-12F LC-MTP OM3 Cassette – loaded (MOD 1)	208-112-MOD1
Enbeam HD 6P-12F LC-MTP OM3 Cassette – loaded (MOD2)	208-112-MOD2
Enbeam HD 6P-12F LC-MTP OM4 Cassette – loaded (standard)	208-113
Enbeam HD 6P-12F LC-MTP OM4 Cassette – loaded (MOD 1)	208-113-MOD1
Enbeam HD 6P-12F LC-MTP OM4 Cassette – loaded (MOD2)	208-113-MOD2
Enbeam Magnetic Patch Cord Manager (6pcs)	208-115

# Excel MTP Fibre Optic Connectivity Configurations

It is possible to configure array cable connecting hardware in different methods. Different methods are published by different standards organisations. The Excel MTP portfolio follows the connecting method prescribed in BS EN 50174-1:2018 section C3 Array connecting hardware interfaces.

The MPO (generic term for an MTP connector) was introduced originally as a method of connecting 12 cores of fibre optic cable in a single connector. The original primary use was to offer a “plug and play” pre-terminated fibre optic solution. Recently applications that require more cores of fibre per channel when using multimode fibre have been introduced and are being developed. Up to, and including, 10 Gigabit Ethernet uses 1 Tx and 1 Rx cores. Applications such as 40 Gigabit Ethernet, over multimode fibre, will use 4 Tx and 4 Rx cores (8 in total for one channel). An MPO such as the MTP by US Conneq offers a convenient connector to present this.

The Excel MTP array cable portfolio has been configured to ensure that it will work with both 2 core channels and array cabling. The Trunk Cables will be with pins and the future MTP Patch Leads (used to connect the equipment to the patch panel) will be without pins. By configuring the MTP range ready for array cable installations particular attention has to be given to labelling the installation. As can be seen in the following sections, when used with duplex fibre cassettes the first connector (cores 1 & 2) are connected to the sixth connector (cores 11 & 12).

### Duplex Channel Configuration

when the cassettes are attached to the trunk cable the following connectivity is achieved:

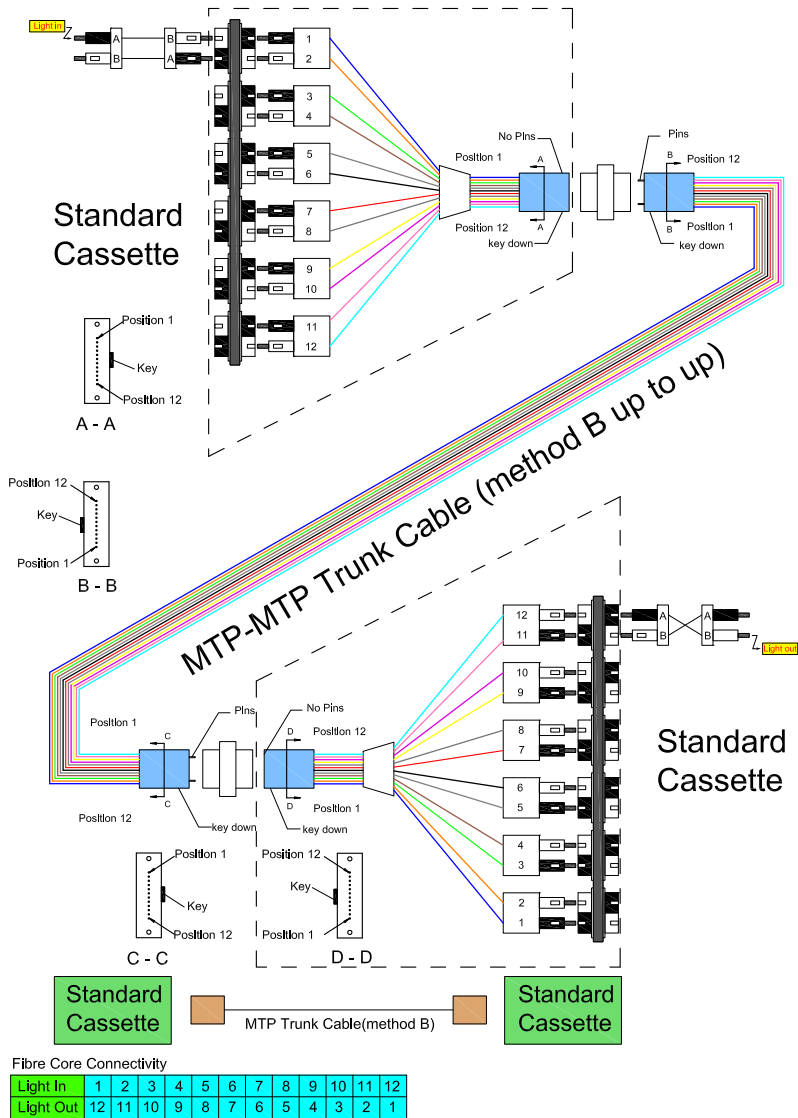

As can be seen, and mentioned above, it is critical that each cassette is labelled to ensure that the ports are correctly identified to avoid confusion.



### Duplex Channel Configuration

when the cassettes are attached to the trunk cable the following connectivity is achieved:

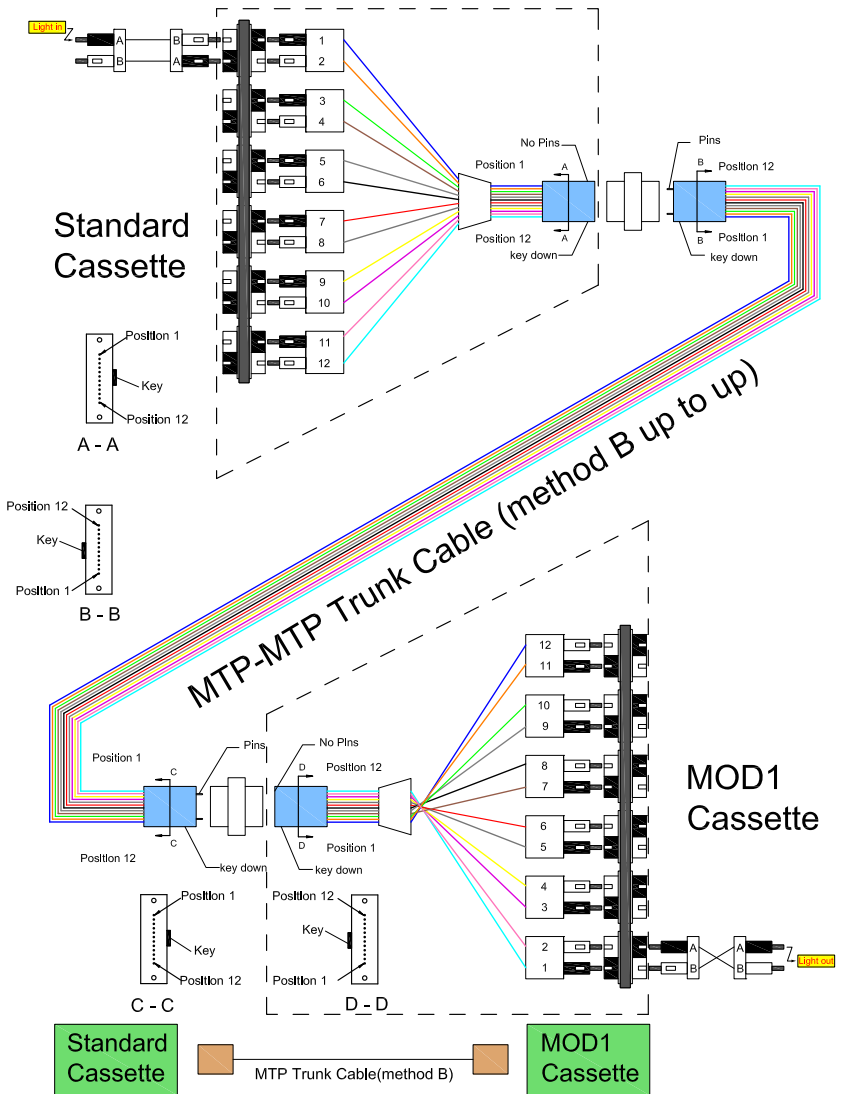

Fibre Core Connectivity

Light In	1	2	3	4	5	6	7	8	9	10	11	12
Light Out	1	2	3	4	5	6	7	8	9	10	11	12

As can be seen, and mentioned above, it is critical that each cassette is labelled to ensure that the ports are correctly identified to avoid confusion.

### Duplex Channel Configuration

when the cassettes are attached to the trunk cable the following connectivity is achieved:

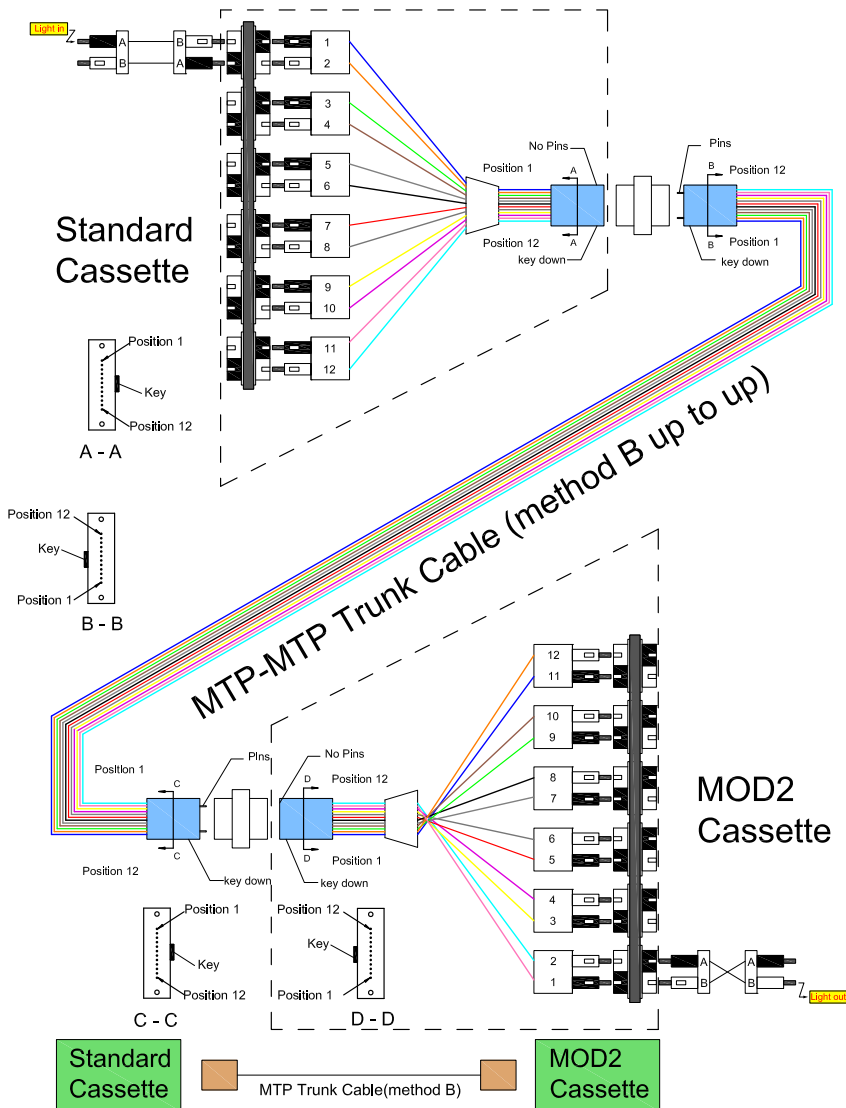

Fibre Core Connectivity

Light In	1	2	3	4	5	6	7	8	9	10	11	12
Light Out	2	1	4	3	6	5	8	7	10	9	12	11

As can be seen, and mentioned above, it is critical that each cassette is labelled to ensure that the ports are correctly identified to avoid confusion.

### MTP Polarity Methods

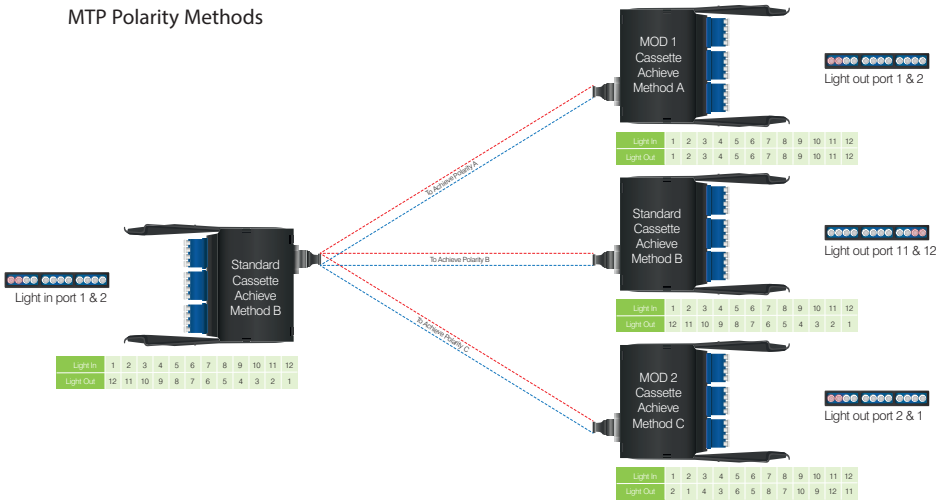

### Enbeam Fibre Panel – 1U 144 Fibre LC Angled

The Enbeam 1U 19" HD Angled panel provides high-density LC patching – 72 ports / 144 fibres in 1U. The angled design negates the need for additional patch cord management, further increasing the potential density of this system. Designed as a pass-through patching panel it features a large rear cable manager for location of the rear cables/patch leads.

The individual 6-port LC adaptors are spaced to allow easy mating and un-mating of LC connectors.

The angled front design of the panel allows for improved cable management.

#### Features

- 1U 19" High Density – 144 Fibre Capacity
- Angled design
- Pass-through design
- 12-fibre adaptors allows easy LC connection/removal
- 25 Year System Warranty Available



Description	Part Number
Enbeam 1U 144C HD SM Coupler Panel	208-150
Enbeam 1U 144C HD OM3 Coupler Panel	208-151
Enbeam 1U 144C HD OM4 Coupler Panel	208-152

## Enbeam High Density MTP Fibre Optic 5 Cassette Patch Panel - Unloaded



Enbeam 1U High Density MTP Cassettes Patch Panel offers an expandable fibre optic deployment. The front drop down panel offers protection to the installed patch cords and also a large labeling field. Further, panel identification labeling, may be fixed to the drop down panel in the closed position. The panel is supplied with a card label that can be replaced with the users own label or adhesive engraved label as preferred. This 1U patch panel is mounted in standard 19" profiles using cage nuts and screws. Once mounted the panel can be pulled forward by releasing two side catches to facilitate easy access to the LC connectors in the cassettes. Up to 5 cassettes may be mounted in this patch panel this presents a maximum of 120 fibre cores in LC Duplex connectors (60 LC Duplex Connectors). Multimode and Singlemode cassettes are available in either 12 or 24 core configurations. The cassettes are inserted in the front and fixed at the rear ensuring a secure mounting.

### Features

- High Density - 120 Fibres Maximum
- Sliding Panel for Access
- Accepts up to 5 cassettes
- Drop Down Front Panel
- 25 Year System Warranty Available
- Large Labeling Field

Description	Part Number
Enbeam 1U High Density MTP Patch Panel (Unloaded)	208-002
Enbeam LC Extraction Tool	208-023
<b>Compatible Cassettes</b>	
Enbeam High Density OM3 MTP Fibre Cassette 6 Duplex LC (12 Core)	208-011
Enbeam High Density OM3 MTP Fibre Cassette 12 Duplex LC (24 Core)	208-012
Enbeam High Density OM4 MTP Fibre Cassette 6 Duplex LC (12 Core)	208-013
Enbeam High Density OM4 MTP Fibre Cassette 12 Duplex LC (24 Core)	208-014
Enbeam High Density OS2 (APC) MTP Fibre Cassette 6 Duplex LC (12 Core)	208-015-APC
Enbeam High Density OS2 (APC) MTP Fibre Cassette 12 Duplex LC (24 Core)	208-016-APC

Please check the Excel High Density MTP Fibre Optic Specification Sheet to ensure that the correct versions of the product is ordered to achieve the channel configuration desired.

## Enbeam High Density MTP Angled Fibre Optic 4 Cassette Patch Panel - Unloaded

Enbeam 1U High Density Angled MTP Cassettes Patch Panel offers an expandable fibre optic deployment. The front drop down panel offers protection to the installed patch cords and also a large labeling field. Further, panel identification labeling, may be fixed to the drop down panel in the closed position. The panel is supplied with a card label that can be replaced with the users own label or adhesive engraved label as preferred. This 1U patch panel is mounted in standard 19" profiles using cage nuts and screws. Once mounted the panel can be pulled forward by releasing two side catches to facilitate easy access to the LC connectors in the cassettes. Up to 4 cassettes may be mounted in this patch panel this presents a maximum of 96 fibre cores in LC Duplex connectors (48 LC Duplex Connectors). The angle mounting of the cassettes reduces the bend on the connected fibre cords. Multimode and Singlemode cassettes are available in either 12 or 24 core configurations. The cassettes are inserted in the front and fixed at the rear ensuring a secure mounting.

### Features

- High Density - 96 Fibres Maximum
- Sliding Panel for Access
- Accepts up to 4 cassettes
- Drop Down Front Panel
- 25 Year System Warranty Available
- Large Labeling Field



Description	Part Number
Enbeam 1U High Density Angled MTP Patch Panel (Unloaded)	208-004
Enbeam LC Extraction Tool	208-023
Compatible Cassettes	
Enbeam High Density OM3 MTP Fibre Cassette 6 Duplex LC (12 Core)	208-011
Enbeam High Density OM3 MTP Fibre Cassette 12 Duplex LC (24 Core)	208-012
Enbeam High Density OM4 MTP Fibre Cassette 6 Duplex LC (12 Core)	208-013
Enbeam High Density OM4 MTP Fibre Cassette 12 Duplex LC (24 Core)	208-014
Enbeam High Density OS2 (APC) MTP Fibre Cassette 6 Duplex LC (12 Core)	208-015
Enbeam High Density OS2 (APC) MTP Fibre Cassette 12 Duplex LC (24 Core)	208-016

Please check the Excel High Density MTP Fibre Optic Specification Sheet to ensure that the correct versions of the product is ordered to achieve the channel configuration desired.



## Enbeam MTP Through Coupler Panel - Unloaded



Enbeam 1U MTP Through Coupler Patch Panel offers offers housing for up to 12 US Conec MTP Through Couplers. The patch panel is based on the popular Excel Fibre Optic Patch Panels to offer flexibility in mounting position and use. The patch panel is supplied empty, with the MTP coupler positions fitted with blank caps. It is supplied empty so that only the required number of MTP Through Couplers have to be installed on “day one” and allow for future expansion. The patch panel is slide opening to gain access during installation. Incoming trunk cables, that have multiple MTP connectors, are fitted with stuffing glands. The panel has multiple, “key hole” shape, apertures to accommodate the attachment of the stuffing gland. The 12 positions, when full, results in this panel supporting the connection of up to 144 cores of optical fibre.



### Features

- Accepts up to 12 MTP Through Couplers
- 25 Year System Warranty Available
- Supplied empty for custom deployments
- 1U Height
- Multiple “Key Hole” Aperture entry for Trunk Cables

Description	Part Number
Enbeam 1U MTP Through Coupler Patch Panel -12 Port - Unloaded	208-020
Enbeam US Conec MTP Aligned Adaptor 5306	208-021



## Enbeam Fibre Optic MTP® Cassettes

The Enbeam Fibre Optic MTP® Cassette mounts directly into either the High Density MTP Fibre Optic 5 cassette or the High Density MTP Angled Fibre Optic 4 Cassette Patch Panel. These patch panels are both 1U high and mount directly into the 19" cabinet profiles. This range of products has been designed and manufactured to support both the pre-terminated and the emerging 40/100 Gigabit Ethernet fibre optic installations. The cassettes are terminated with the superior quality US Conec MTP Elite® connector. Both 6 and 12 Duplex LC (12 and 24 core) cassettes are available.

The 6 Duplex Port has one MTP Elite® connector on the rear and the 12 Duplex Port version has two. The cassettes are factory terminated and tested ensuring optimal performance when connected to the desired Excel MTP® Trunk Cable. Simply inspect the MTP® end faces of the cable and cassette and connect. OM3, OM4 and OS2 categories of fibre optic cassettes are available depending on the desired class of channel.



### Features

- Factory terminated and tested
- US Conec MTP Elite® Connectors
- 6 or 12 Duplex LC Ports
- OM3, OM4 or OS2
- 25 Year System Warranty Available
- Compatible with Excel Fibre Optic Cassette Patch Panel
- Test certificate supplied
- APC Singlemode connector as standard

## Performance of MTP System

### Fibre Optic Cable Performance

#### OM3 & OM4 – Multimode

Parameter	Value
Modal-Field Diameter	5 ± 2.5 µm
	125 ± 1 µm
Numerical Aperture	0.20 ± 0.015 µm

Category	Size	Bandwidth Overfilled launch		Effective laser launch
		850 nm	1300 nm	850 nm
OM3	50/125µm	1500 MHzkm	500 MHzkm	2000 MHzkm
OM4	50/125µm	3500 MHzkm	500 MHzkm	4700 MHzkm

#### OS2 – Singlemode

Parameter	Value
Modal-Field Diameter	9 ± 0.4 µm
	125 ± 0.7 µm
Numerical Aperture	0.20 ± 0.015 µm

OS2 Wavelength	Maximum attenuation
1310 nm	0.4 dB/km
1383 nm	0.4 dB/km
1550 nm	0.4 dB/km

## Enbeam Fibre Optic MTP® Cassettes (continued)

### MTP Elite Connector Performance

Parameter	Value
Multimode - Insertion Loss	0.1dB Typical (All Fibres) 0.35dB Maximum (Single Fibre)
Multimode - Optical Return Loss	> 20dB
Singlemode - Insertion Loss	0.10dB Typical (All Fibres) 0.35dB Maximum (Single Fibre)
Singlemode (APC) - Optical Return Loss	> 60dB

Description	Part Number
Enbeam High Density OM3 MTP Fibre Cassette 6 Duplex (12 Core)	208-011
Enbeam High Density OM3 MTP Fibre Cassette 12 Duplex (24 Core)	208-012
Enbeam High Density OM4 MTP Fibre Cassette 6 Duplex (12 Core)	208-013
Enbeam High Density OM4 MTP Fibre Cassette 12 Duplex (24 Core)	208-014
Enbeam High Density OS2 (APC) MTP Fibre Cassette 6 Duplex (12 Core)	208-015
Enbeam High Density OS2 (APC) MTP Fibre Cassette 12 Duplex (24 Core)	208-016
Enbeam 2 way MTP Fibre Cassette - Empty with Blanks	208-017
Enbeam 2 way MTP Fibre Cassette - Aligned Couplers Fitted	208-018

### MTP Polarity Methods

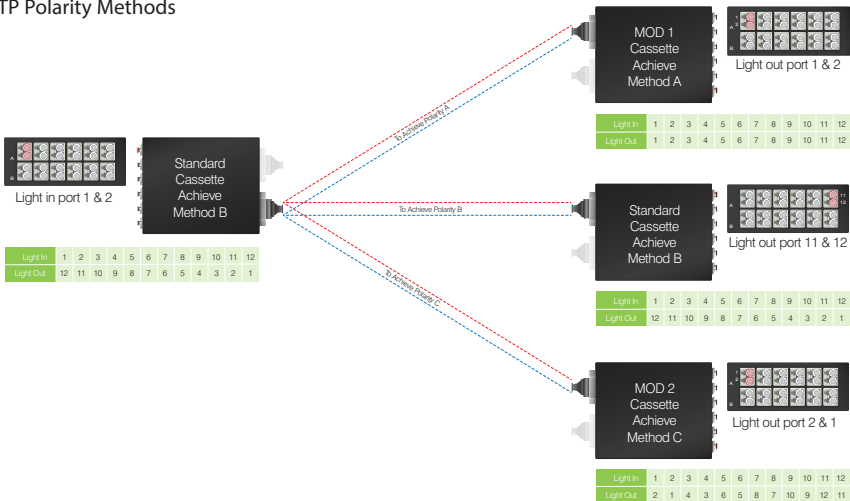



## Excellerator MTP Elite® Fibre Optic Trunk Cables

The Excellerator MTP Elite® Trunk Cables offer pre-terminated optical fibre that is factory tested in a range of core counts. The trunk cable is manufactured with multiple, 12 core MTP Elite® connectors to give 12, 24, 36, 48, 72, 96 or 144 core cables. The US Conec MTP Elite® connector has been chosen as the MPO (Multiple-Fibre Push-On/Pull-off) for superior performance with low loss properties. The MTP Elite® is the superior connector from the superior MPO manufacturer. Each cable is tested in the factory and is supplied with the test certificate. Each end of the cable has the MTP Elite® connector(s) protected with a flexible hose.

The trunk cable assemblies are available in OM3, OM4 and OS2. Bespoke lengths are offered (to the nearest metre). In the case of the 24 core and greater the cable is constructed of multi-core units.

### Features

- US Conec MTP Elite® connectors used
- 12 Core Connectors
- 12 to 144 Core available (multiple MTP Elite®s)
- OM3, OM4 or OS2
- Factory tested
- 25 Year System Warranty Available
- APC Singlemode connector as standard

### Simple ordering process

The construction of the MTP Elite® installation starts with ordering the required products. This is a very simple process.

- What is the length of the trunk cable required?
  - Round up to the nearest metre in length
  - Do not forget any vertical drops
  - 'Service Loop', correctly managed does not affect the performance of fibre
- Fibre grade
  - OM3, OM4 and OS2 are available
- Core size
  - 12, 24, 36, 48, 72, 96 and 144 core available
- This corresponds to 1, 2, 3, 4, 6, 8 or 12 MTP Elite® connectors at each end

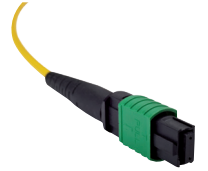
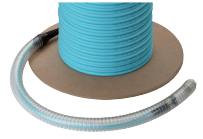

Description	Part Number
Excellerator OM3 yy Core MTP Trunk Cable xxx m	208-OM3-yyC-MTP-xxx
Excellerator OM4 yy Core MTP Trunk Cable xxx m	208-OM4-yyC-MTP-xxx
Excellerator OS2 yy Core MTP Trunk Cable xxx m	208-OS2-yyC-MTP-xxx

yy = core size (12, 24, 36, 48, 72, 96 or 144)

xxx = length in metres (to the nearest metre)

e.g. 208-OM3-48C-MTP-150 Excel OM3 48 Core MTP Trunk Cable 150 m

## Excelerator MTP to LC Fan Out Cables



Excelerator MTP to LC Fan Out Cables offer a flexible way to connect fibre optic equipment to MTP Trunk Cables. The assembly uses the superior MTP Elite connector (without pints) from US Conec offering high performance and longevity. Each fan out cable is constructed with mini break out cable so that the fibre is a single piece in the assembly. For fan out cables that are 24 core and above the MTP is presented on a 600 mm section and the LC connectors are branched out and staggered to manage the connectivity. Please refer to the Specification Sheets available from [www.excel-networking.com](http://www.excel-networking.com) for the dimensions and connectivity arrangements. The overall length is specified by the customer when ordering, see part number table below.

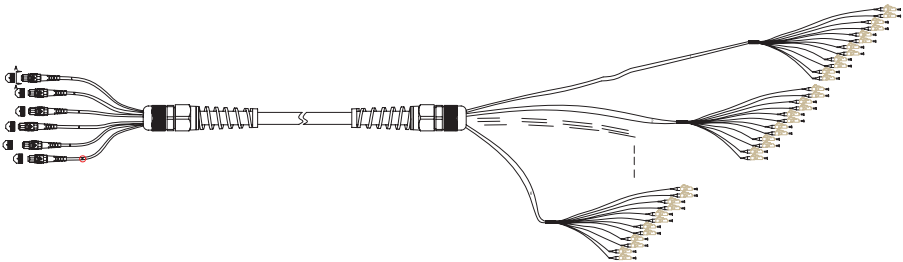

### Features

- MTP Elite® connectors
- OM3, OM4 & OS2 Categories available
- 12, 24, 72, 96 & 144 Core cable assemblies available
- Custom length
- LSOH Cable Jacket
- APC Singlemode connector as standard



Description	Part Number
Excelerator OM3 MTP to LC Fan Out Cable – 12 Core – xxx m	208-OM3-12C-FAN-xxx
Excelerator OM3 MTP to LC Fan Out Cable – 24 Core – xxx m	208-OM3-24C-FAN-xxx
Excelerator OM3 MTP to LC Fan Out Cable – 72 Core – xxx m	208-OM3-72C-FAN-xxx
Excelerator OM3 MTP to LC Fan Out Cable – 96 Core – xxx m	208-OM3-96C-FAN-xxx
Excelerator OM3 MTP to LC Fan Out Cable – 144 Core – xxx m	208-OM3-144C-FAN-xxx
Excelerator OM4 MTP to LC Fan Out Cable – 12 Core – xxx m	208-OM4-12C-FAN-xxx
Excelerator OM4 MTP to LC Fan Out Cable – 24 Core – xxx m	208-OM4-24C-FAN-xxx
Excelerator OM4 MTP to LC Fan Out Cable – 72 Core – xxx m	208-OM4-72C-FAN-xxx
Excelerator OM4 MTP to LC Fan Out Cable – 96 Core – xxx m	208-OM4-96C-FAN-xxx
Excelerator OM4 MTP to LC Fan Out Cable – 144 Core – xxx m	208-OM4-144C-FAN-xxx
Excelerator OS2 (APC) MTP to LC Fan Out Cable – 12 Core – xxx m	208-OS2-12C-FAN-xxx
Excelerator OS2 (APC) MTP to LC Fan Out Cable – 24 Core – xxx m	208-OS2-24C-FAN-xxx
Excelerator OS2 (APC) MTP to LC Fan Out Cable – 72 Core – xxx m	208-OS2-72C-FAN-xxx
Excelerator OS2 (APC) MTP to LC Fan Out Cable – 96 Core – xxx m	208-OS2-96C-FAN-xxx
Excelerator OS2 (APC) MTP to LC Fan Out Cable – 144 Core – xxx m	208-OS2-144C-FAN-xxx

xxx = length in metres (to the nearest metre)

## Outlets

### Enbeam FTTH Surface Mounted Boxes and Faceplates with Shutters

The Enbeam FTTH Surface mount box and faceplate has been designed for applications such as Fibre to the Home or Fibre to the Desk.

#### Features

- FTTH Surface mount box and faceplate
- LCAPC Duplex or SCAPC Simplex
- Supplied with shutters



Description	Part Number
Enbeam FTTH Faceplate 2 x Shuttered SCAPC Simplex - White	200-443
Enbeam FTTH Faceplate 2 x Shuttered LCAPC Duplex – White	200-444
Enbeam FTTH Faceplate 1 x Shuttered LCAPC Duplex – White	200-445

### Enbeam Enbeam FTTH Outlets

The Excel Enbeam FTTH Outlets have been designed for applications such as Fibre to the Home or Fibre to the Desk.

#### Features

- Hinged Splice Tray holds up to 4 heatshrink splice protectors
- Multiple cable entry points
- Fixing hardware included
- For use with flangeless adaptors
- Accepts LC duplex or SC Simplex adaptors
- 2 splice protectors supplied as standard



Description	Part Number
Enbeam FTTH Outlet up to 4 Fibre Unloaded	200-446
Enbeam FTTH Outlet Loaded 2xSC/APC OS1/OS2 simplex Adaptors	200-447
Enbeam FTTH Outlet up to 8 Fibre Unloaded	200-448
Enbeam FTTH Outlet Loaded 4xSC/APC simplex Adaptors	200-449
Enbeam FTTH 4 Port SC Outlet with 30 meter Drop Cable	200-449-30
Enbeam FTTH 4 Port SC Outlet with 50 meter Drop Cable	200-449-50
Enbeam FTTH 4 Port SC Outlet with 70 meter Drop Cable	200-449-70
Compatible with	
Enbeam FTTH DIN Rail Mounting bracket for FTTH units	200-442





## Enbeam Tamperproof Fibre Optic Patch Boxes



Enbeam tamperproof patch boxes are ideal for ensuring that an installation is kept safe and enclosed even when a rack or comms enclosure is not available. The design allows for a small footprint to be deployed in remote locations.

Description	Part Number
4 Port ST Multimode Loaded Tamperproof Conduit	202-020
4 Port ST Loaded Tamperproof Wall Mount Trunking	202-022

## Enbeam Fibre Optic Patch Boxes



Excel Enbeam provides an extensive range of ST, SC (Duplex) and LC (Quad) patch boxes suitable for wall, floor or desk mounting. With a 20mm knock out on every side and pre-drilled fixing holes. Ideal for conduit or cable gland entry this new range allows you to select the perfect box to suit your application. The number of ports shown denotes the number of adaptors. SC adaptors are Duplex style and offer two fibre connections per port. LC adaptors are Quad style and offer four fibre connections per port.

### Features

- One piece body construction eliminates fibre snagging
- Available in ST, SC (Duplex) and LC (Quad) connector styles
- Multimode adaptors
- Each unit includes the enclosure fitted out with in-line adaptors, 24 way splice bridge and 4 x self adhesive cable management ties

Description	Dimensions	Part Number
ST Patch Box - 4 Port (4 Core)	110mm x 110mm x 40mm	202-024
ST Patch Box - 8 Port (8 Core)	160mm x 160mm x 40mm	202-025
ST Patch Box - 12 Port (12 Core)	160mm x 160mm x 80mm	202-026
ST Patch Box - 16 Port (16 Core)	160mm x 160mm x 80mm	202-027
SC Patch Box - 2 Port Duplex (4 Core)	110mm x 110mm x 40mm	202-028
SC Patch Box - 4 Port Duplex (8 Core)	160mm x 160mm x 40mm	202-029
SC Patch Box - 6 Port Duplex (12 Core)	160mm x 160mm x 80mm	202-030
SC Patch Box - 8 Port Duplex (16 Core)	160mm x 160mm x 80mm	202-031
LC Patch Box - 2 Port Quad (8 Core)	110mm x 110mm x 40mm	202-107
LC Patch Box - 4 Port Quad (16 Core)	160mm x 160mm x 40mm	202-108
LC Patch Box - 6 Port Quad (24 Core)	160mm x 160mm x 80mm	202-109
LC Patch Box - 8 Port Quad (32 Core)	160mm x 160mm x 80mm	202-110

**Note:** Each adaptor on the SC patch box will accept 1 x SC (Duplex) connector or 2 x SC (Simplex) connectors. Each adaptor on the LC patch box will accept 1 x LC (Quad) connector, or 2 x LC (Duplex) connectors or 4 x LC (Simplex) connectors.

Boxes are also available in Singlemode.  
For prices and availability details please call our Sales Office.

## MDU Boxes

The Excel Enbeam MDU Box terminates up to three optical fibre cables offering a designated space for splitters and up to 48 fusion splices. Housing up to 24 adaptors for internal or external applications, the MDU Box offers a cost-effective solution within the FTTH network.



### Features

- Designated splitter area
- Accepts SC simplex Adaptors
- IP55 Rated
- RoHS
- Lockable

**NEW**  
excel

Description	Part Number
Enbeam MDU Box Unloaded (up to 48 fibre)	208-173
Enbeam MDU Box Loaded 12 x SC/APC Simplex Adaptors	208-174
Enbeam MDU Box Loaded 24 x SC/APC Simplex Adaptors	208-175
Enbeam MDU Box Loaded 12 x SC/OS2 SPX Adaptors	208-176
Enbeam MDU Box Loaded 24 x SC/OS2 SPX Adaptors	208-177
Enbeam MDU Box Loaded 12 x SC/OM3 SPX Adaptors	208-178
Enbeam MDU Box Loaded 24 x SC/OM3 SPX Adaptors	208-179
Enbeam MDU Box Loaded 12 x SC/OM4 SPX Adaptors	208-180
Enbeam MDU Box Loaded 24 x SC/OM4 SPX Adaptors	208-181
Compatible with	
SC Simplex Adaptor Multimode - Beige	200-570
SC Simplex Adaptor Multimode - Violet	201-130
SC Simplex Adaptor Multimode - Aqua	201-135
SC Simplex Adaptor Singlemode - Blue	200-571
SC APC Adaptor Singlemode - Green	200-566

## Demarcation Boxes

The Enbeam Demarcation Box has been designed to be wall or DIN rail mounted with the capacity to hold 12 to 24 fibre. The flexibility to use tight buffered / loose Tube and MTP/MPO fan-outs makes this enclosure suitable for multiple applications. With top and bottom cable entry gives the ability to pass cables through the enclosure allowing fibres to be broken out and spliced. The hinged splice tray platform allows full and easy access to connections and enables storage of excess fibre whilst maintaining the correct bend radius.

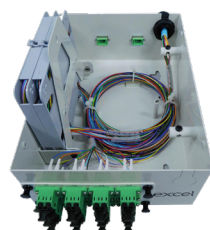

### Features

- 25 Year System Warranty
- Wall or Din rail mountable
- Accepts LC Duplex & SC Simplex
- Hinged splice trays

**NEW**  
excel

Description	Part Number
Enbeam 12 LC Dplx SM (Blue) Demarcation Box	208-200
Enbeam 12 LC Dplx MM (Beige) Demarcation Box	208-202
Enbeam 12 LC Dplx MM (Aqua) Demarcation Box	208-204
Enbeam 12 SC Splx SM APC (Green) Demarcation Box	208-206



## DIN Rail Boxes



The Enbeam DIN rail box has been designed to be wall or DIN rail mounted with the capacity to hold 12 to 24 fibres. The flexibility to use either tight buffered and loose tube makes this enclosure suitable for multiple applications. The hinged splice tray platform allows full and easy access to connections and enables storage of excess fibre whilst maintaining the correct bend radius.

### Features

- 24 way Splice Bridge
- Multiple cable entry points
- Accepts LC Duplex or SC Simplex adaptors
- Integrated FRP tie points
- DIN or wall mountable
- RoHS, Reach compliant
- UL-94-VO



Description	Part Number
Enbeam 12 SC SX SM (Blue) DIN Rail Box	208-210
Enbeam 12 SC SX SM APC (Green) DIN Rail Box	208-211
Enbeam 12 SC SX MM (Beige) DIN Rail Box	208-212
Enbeam 12 SC SX MM (Aqua) DIN Rail Box	208-214
Enbeam 12 LC DX SM (Blue) DIN Rail Box	208-215
Enbeam 12 LC DX SM APC (Green) DIN Rail Box	208-216
Enbeam 12 LC DX MM (Aqua) DIN Rail Box	208-219

## Dome Enclosures



The Excel Enbeam Dome enclosure allows up to 288 fibres to be installed using compression glands to seal the unit, allowing quick and simple installation methods, without the need for specialist tools. Its IP68 rating allows the unit to be externally mounted on walls, pole or pit applications whilst retaining its performance capability.

### Features

- Up to 144 Fibre
- Hinged Splice Tray holds up to 24 heatshrink splice protectors
- IP68
- UV Resistant
- Termination and splice kit included
- Cable entry/exit 4 round 1 x uncut
- Pole Mount Included
- RoHS, Reach compliant

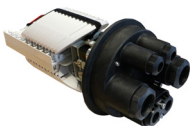

Description	Part Number
Enbeam 48 Fibre Dome Enclosure	208-500
Enbeam 72 Fibre Dome Enclosure	208-501
Enbeam 96 Fibre Dome Enclosure	208-502
Enbeam 144 Fibre Dome Enclosure	208-503
Enbeam 288 Fibre Splice Enclosure (Dome Type)	208-508

## Splice Enclosures

The Enbeam Hinged 144 Fibre Splice Enclosure has been designed to allow up to 144 fibres to be spliced and housed within an IP68 rated durable enclosure, which is ideal for harsh environment applications. The enclosure is mechanically sealed via compression glands and 4 compression latches, to allow re-entry without compromising the integrity of the unit. The enclosures have the ability to be mounted in several ways using different mounting brackets (see additional mounting options); wall, pit, pole and aerial. The enclosure can also house PLC splitters for use in Passive Optical Networks

### Features

- IP68 rated to 1.5 meters
- Holds up to 144 single fibres
- Integrated pressure valve
- Mechanically sealed (compression)

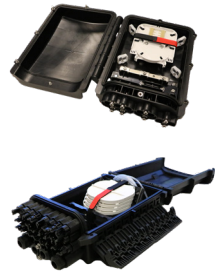

Description	Part Number
Enbeam Hinged Wall Mount Dome Enclosure 60 Splice	208-504
Enbeam Hinged 48 Fibre Splice Enclosure Flat Type	208-506
Enbeam Hinged 144 Fibre Splice Enclosure Flat Type	208-507



The Excel Lockable IP65 Splice Enclosure can be used to terminate fibre to the internal patching field; 24 single fibres when using LC Quad adaptors and 12 when using SC Duplex adaptors. The enclosure also offers space to house a PLC splitter offering a flexible solution for any Passive Optical Network (PON). The robust ABS enclosure can be installed in most indoor and outdoor applications.

### Features

- IP65 rated to 1.5 meters
- Holds up to 24 single fibres
- Mechanically sealed (compression)
- Internal splice tray
- Integrated fibre management
- Suitable for PLC Splitters



Description	Part Number
Enbeam IP65 Lockable Splice Enclosure 24 Fibre	208-183



201-141

Compatible Adaptors	
Description	Part Number
Excel Enbeam SC/APC Duplex Adaptor Singlemode	200-567
Excel Enbeam LC Quad Adaptor Multimode	201-138
Enbeam LC Quad Flangeless Adaptor Multimode - Violet	201-141
Enbeam LC Quad Adaptor Multimode - Rose	201-133
Enbeam LC Quad Adaptor Multimode - Aqua	201-138
Enbeam LC Quad Flangeless Adaptor Multimode - Aqua	201-142
Enbeam LC Quad Adaptor Multimode	200-568
Enbeam LC Quad Adaptor Singlemode	200-569
Enbeam LC Quad Flangeless Adaptor Multimode	200-579
Enbeam LC Quad Flangeless Adaptor Singlemode	200-580





## Environ Enclosures



The Excel range of Environ Enclosures has been designed to be a multifunctional set of products, which can form part of a network in multiple locations. With the ability to change the internal structures to fit most applications within a passive optical network and edge of network cabling designs, these enclosures can be adapted to house either fibre or copper (or both) within a confined space. These enclosures are suitable for risers, equipment rooms and remote locations.

Description	Dimensions (mm - H x W x D)	U Size and Capacity	Part Number
Environ Residential Consolidation Enclosure	453 x 430 x 160	1U - up to 12 copper ports	100-658
Environ Small Enclosure	300 x 300 x 100	DIN Rail Mountable Only - up to 24 copper ports	100-653
Environ Medium Enclosure	604 x 400 x 125	2U - up to 24 copper ports	100-651
Environ Large Enclosure*	650 x 600 x 250	5U - up to 120 copper ports	100-659

\* Features a 19" mounting rail Multiple fibre ports can be installed within these enclosures





## Enbeam 2 Door Lockable Fibre Optic Wall Mounted Enclosure

These patch boxes are designed for high-density, secure terminations. Their two door design ensures that both the terminations and the patching are safe. The boxes have 20mm knockouts and pre-drilled fixing holes.

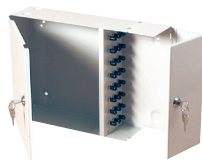

### Features

- Manufactured with a one piece body, an interchangeable plate and hinged lockable doors
- ST, SC (Duplex) and LC (Quad) in-line multimode adaptor plates available
- All boxes include the box itself and a fitted adaptor plate loaded with the appropriate number of in-line adaptors, 24 way splice bridge, cable entry gland and 4 x self adhesive cable management ties

### Technical Data

Dimensions: 360mm x 250mm x 90mm

Description	Part Number
12 Port ST (12 Core) Lockable Patch Box – Loaded	202-035
24 Port ST (24 Core) Lockable Patch Box – Loaded	202-036
6 Port SC Duplex (12 Core) Lockable Patch Box – Loaded	202-037
12 Port SC Duplex (24 Core) Lockable Patch Box – Loaded	202-038
6 Port LC Quad (24 Core) Lockable Patch Box - Loaded	202-033
12 Port LC Quad (48 Core) Lockable Patch Box - Loaded	202-034

## Enbeam 1 Door Fibre Optic Wall Mounted Enclosure

The Enbeam lockable wall mounted enclosures provide a cost effective, secure method of terminating fibre where standard 19" cabinets and patch panels are not suitable. Each unit is supplied unloaded, just add to your chosen enclosure the required plate and adaptors. Standard wall box (200-987) includes Splice Management.

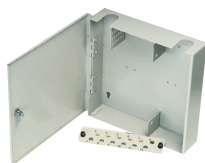

200-987

	Compact 250 x 250 x 55mm		Standard 370 x 330 x 80mm	
Wall Mounted Enclosure	200-985		200-987	
Adaptor Plates to suit above wall boxes	ST	SC (Duplex)	ST	SC (Duplex)
4 x Adaptor Plate	-	200-995	-	-
6 x Adaptor Plate	-	-	-	-
8 x Adaptor Plate	200-991	-	-	-
12 x Adaptor Plate	-	-	-	200-998
16 x Adaptor Plate	-	-	-	-
24 x Adaptor Plate	-	-	200-994	-
MM Compatible Adaptor	200-350	200-365	200-350	200-365
SM Compatible Adaptor	200-350-SM	200-366	200-350-SM	-



## Fibre Optic Connector Crimp Tool



### Features

- Used for crimping connector strain relief crimp rings
- Correct pressure is applied as the cycle ratchet prevents the tool being opened until the dies have been completely closed
- Different connector styles are suited with a wide range of tools



Cavity Shapes	Cavity Size	Part Number
1 round, 2 hex	.105", .090", .190"	202-069
3 hexagonal	.151", .178", .213"	202-070

## Fibre Stripper



Cable cutting and preparation tool to suit a wide range of fibre cables.

### Features

- Blade has two holes
- Tight jacket patch cable is stripped by 1mm hole
- Spring action handles can be locked when not in use
- 140 um hole strips 250 um primary buffer

Description	Part Number
Clauss Fibre Stripper	202-089

View our Fibre Cleaning Guide and Infographic for more information about fibre cleaning



## Enbeam Yellow Duct System

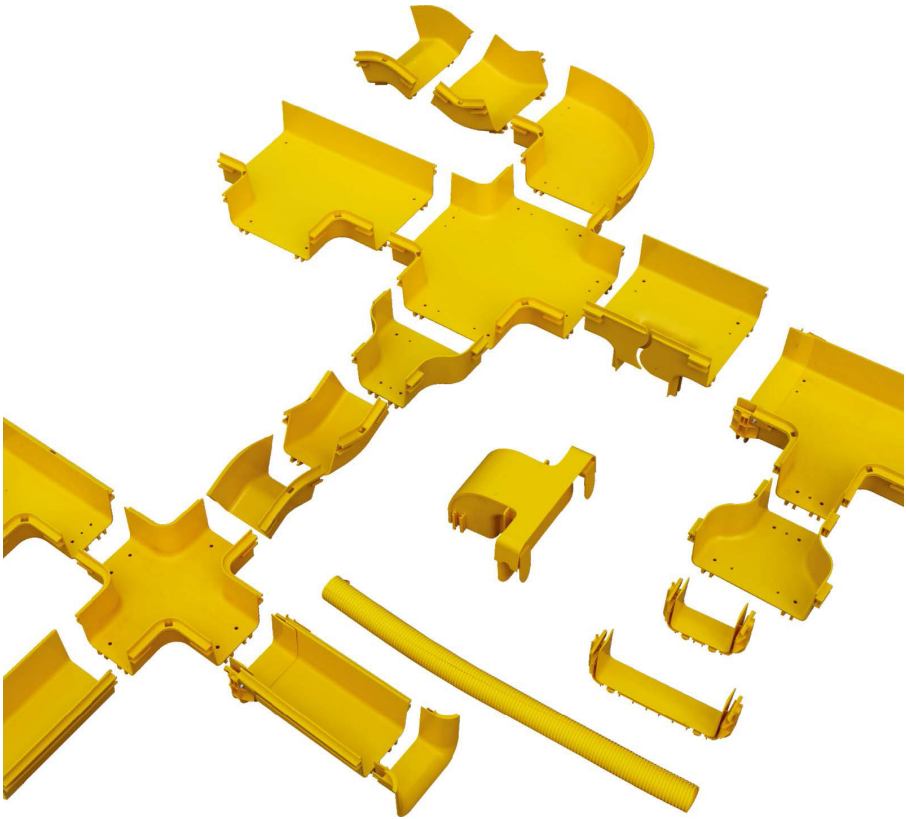

Piecing together in individual segments, Excel's duct trunking system is flexible and suitable for an endless array of installations. A range of unique trunking segments in a variety of bend radii and lengths connect together in an infinite number of ways, allowing users to create a fibre storage solution that is fit for purpose.

As each segment of trunking is a standalone piece of plastic, users can simply remove the section of the cover that they need and make changes to the installation without having to disrupt the whole system, which increases the durability and longevity of the system overall.

The system is fully enclosed, protecting the fibre from dirt and dust. Knowing that cleanliness is one of the most important factors when installing fibre optic cable, the fact that this trunking system helps to limit the contamination to the fibre makes it a strong contender for users choosing a trunking option.

Manufactured from a flame-retardant ABS material, the trunking system meets the LSOH standards to further enhance the protection of the cable.

Excel's duct trunking system is easy to assemble; the only tools required are a drill, a screwdriver and a saw to cut the channels to length. The system is designed for speed of installation and minimum labour for the installer.

The system is extremely adaptable and will evolve to suit this demanding market. Currently it is supplied in 120mm and 240mm thickness.

## Enbeam 120mm Fibre Cable Tray

### Loading Capability

2mm Fibre	3mm Fibre
955	424
1433	636
1910	848

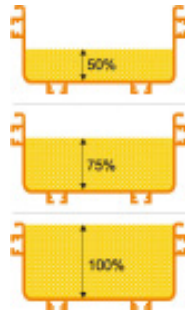

Description	Part Number
120mm x 2000mm PVC Trunking LS0H	460-001
120mm x 2000mm PVC Trunking UL94 V-0	460-048

## Enbeam 240mm Fibre Cable Tray

### Loading Capability

2mm Fibre	3mm Fibre
1910	849
2866	1273
3821	1698

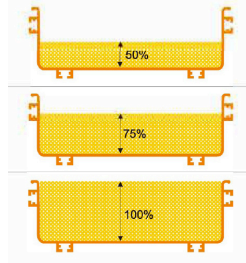
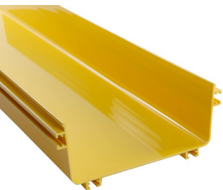

Description	Part Number
240mm x 2000mm PVC Trunking LS0H	460-002
240mm x 2000mm PVC Trunking UL94 V-0	460-049

## Enbeam Connector

Description	Part Number
120mm LS0H Connector	460-003
240mm LS0H Connector	460-004



## Enbeam 90 Degree Bend

Description	Part Number
120mm 90 degree LS0H bend	460-006
240mm 90 degree LS0H bend	460-007



## Enbeam Tee

Description	Part Number
120mm Reducing LS0H Tee	460-014
240mm Reducing LS0H Tee	460-015



## Enbeam Horizontal Tee

Description	Part Number
120mm Horizontal LS0H Tee	460-018
240mm Horizontal LS0H Tee	460-019

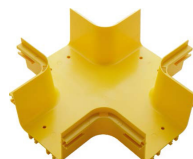

## Enbeam Vertical Tee

Description	Part Number
240mm to 120mm Vertical LS0H Tee	460-017



## Enbeam Reducing Tee

Description	Part Number
240mm to 120mm Reducing LS0H Tee	460-016



## Enbeam Reducer



Description	Part Number
120mm LS0H Reducer	460-005

## Enbeam Trumpet End



Description	Part Number
120mm LS0H Trumpet End	460-020
240mm LS0H Trumpet End	460-021

## Enbeam External Riser 45°



Description	Part Number
120mm LS0H External Riser 45°	460-010
240mm LS0H External Riser 45°	460-011

## Enbeam Internal Riser 45°

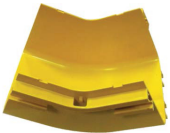

Description	Part Number
120mm LS0H Internal Riser 45°	460-008
240mm LS0H Internal Riser 45°	460-009

## Enbeam End Cap



Description	Part Number
120mm LS0H End Cap	460-022
240mm LS0H End Cap	460-023

## Enbeam Universal Exit Kit



Description	Part Number
Universal Exit Kit - LS0H	460-024

Fits to both 120mm and 240mm trunking

## Enbeam Universal Trunking Exit Kit

Description	Part Number
Universal Trunking Exit Kit - LSOH	460-025

Fits to both 120mm and 240mm trunking



## Enbeam Hanging Bar

Description	Part Number
120mm Hanging Bar	460-026
240mm Hanging Bar	460-027

For use with 12 to 14mm threaded rod



## Enbeam Top Stand

Description	Part Number
120mm Top Stand	460-030
240mm Top Stand	460-031

Threaded rod and fixings included



## Enbeam Hanging Set

Description	Part Number
120mm Hanging Set	460-053
240mm Hanging Set	460-054



## Enbeam L Bracket

Description	Part Number
120mm L Bracket	460-028
240mm L Bracket	460-029



## Enbeam L Bracket Support

Description	Part Number
120mm L Bracket Support	460-055
240mm L Bracket Support	460-056





## Enbeam Covers



Description	Part Number
120mm PVC Trunking Cover LS0H	460-032
240mm PVC Trunking Cover LS0H	460-033
120mm PVC Trunking Cover UL94 V-0	460-050
240mm PVC Trunking Cover UL94 V-0	460-051

## Enbeam Tee Cover



Description	Part Number
120mm Tee Cover	460-042
240mm Tee Cover	460-043

## Enbeam Internal Riser Cover



Description	Part Number
120mm Internal Riser Cover	460-036
240mm Internal Riser Cover	460-037

## Enbeam External Riser Cover



Description	Part Number
120mm External Riser Cover	460-038
240mm External Riser Cover	460-039

## Enbeam 90° Bend Cover



Description	Part Number
120mm 90° Bend Cover	460-034
240mm 90° Bend Cover	460-035

## Enbeam Cross Section Cover



Description	Part Number
120mm Cross Section Cover	460-046
240mm Cross Section Cover	460-047

## Enbeam Reducer Cover



Description	Part Number
240mm to 120mm Reducer Cover	460-044



## Fibre Cleaning Tools



High quality fibre optic installation starts with the connectors. Clean connections provide faster transmission rates, higher bandwidth and maintenance-free operation, ultimately offering a more efficient and more effective fibre solution. Excel offer a range of specialised fibre cleaning products to ensure that all Excel fibre-based installations continue to be of the highest quality.

### Swabs, Wipes and Platforms

Presaturated swabs and wipes combine Chemtronics® highly effective cleaners and static dissipative treatments with the convenience of a disposable applicator. Convenient to use and carry around, presaturated wipes and swabs are ideal for field service kits. What's more, they are hermetically sealed to prevent evaporation and maintain solvent effectiveness for efficient long-term use.

#### Features

- May be used wet or dry to remove dirt and oil contamination
- Free of fibres, seams, hard surfaces, bonders and adhesives
- Can be used with Electro-Wash® PX or CZ solvent cleaners
- Convenient size

Description	Part Number
1.25mm Fibre Optic Sleeve Swab	25123X
EFB-11 V-Groove & Ferrule Swab	38542F
EFB-10 2.5mm Fibre Optic Swab	48042F
EFB-12 Fusion Splice Mirror CL	51125F
Coventry Econowipes	6704F
ChemPad Pre-Saturated Pads	CP400
Optic Prep Pre-Saturated Wipes	CP410
Electro-Wash MX Cleaner/Degreaser Wipes	CP421
Fusion Splice Pre-Saturated Wipes	FSA75
Fusion Splice Wipes Tub	FSW
Pocket QBE Fibre Optic End Face Platform	PQBE
QBE Fibre Optic End Face Cleaner	QBE
QBE 2 Fibre Optic End Face Platform	QBE2
SQR Compact Fibre Optic End Face Platform	SQR





## Cleaner and Degreaser

High quality fibre optic installation starts with the connectors. Clean connections provide faster transmission rates, higher bandwidth and maintenance-free operation, ultimately offering a more efficient and more effective fibre solution. Excel offer a range of specialised fibre cleaning products to ensure that all Excel fibre-based installations continue to be of the highest quality.

### Features

- Safe for use on most plastics and all metals
- Fast drying
- Removes grease, dirt, oil, carbon, oxidation
- Spray in any direction, even upside down
- Suitable for use on contacts, relays, switches, connectors, sockets and terminals



Description	Part Number
Typhoon Blast All-Way HFO-1234	ES1624E
Electrowash PX Cleaner/Degreaser	ES810E

## Pens and Connector Tools

Chemtronics® has designed and developed these precision tools specifically to clean micro-contamination encountered in fiber optic telecommunications. From removing end-face contamination on a fiber optic connector, to cleaning contamination from your fusion splicer, these ultra-clean tools will make clear, clean and safe connections, fast and easy.

### Features (Connector Tools)

- Cleans connectors on back plane and on jumpers
- Uses Combination Cleaning™ process for first time cleaning, every time
- Effective for the widest range of contaminants
- Easy to use for quick and reliable cleaning
- Rugged and durable, great for all work sites
- Cleans UPC and APC connectors
- Up to 800 cleanings per kit -- 33% more than other tools!

### Features (Pens)

- Nonflammable aqueous cleaner
- Removes a broad range of soils: dust, oils, soils, complex soils, salts and other contaminants
- Residue free, low VOC, low global warming potential (GWP)
- Portable and easily transportable
- Cleans connectors with QbE® Cleaning Platform or with CCT™ Clear Connection Tool
- Dissipates static charge which can attract airborne contaminants
- Plastic safe and compatible for all fiber optic connectors
- Approximately 400 end face cleanings per pen

Description	Part Number
Clear Connection Tool	CCT-125
Clear Connection Tool	CCT-250
Clear Connection Tool MPO	CCT-MPO
Fiber-Wash MX Precision	FW2150
Fiber-Wash NF Precision	FW2170
Fiber-wash AQ Precision	FW2190



## Cleaning Kits

We stock a selection of cleaning kits suitable for different cleaning requirements. These are ideal starter packs, or to accommodate a complete overhaul of your fibre cleaning practices, ensuring that you have every element of your installation covered when it comes to assuring cleanliness and effectiveness.

### Features

- All required cleaning tools and materials in one handy carry-case
- An ideal starter pack

Description	Part Number
Portable Fiber Optic Cleaning Kit	CCK-1E
Fiber Optic Cleaning Kit	CFK1000E
End Face Cleaning Kit	CFK1013E
FTTX All-Connect Cleaning Kit	CFK1202E
Fusion Splice Prep and Equipment	FSK1000E

## Fujikura One Click

The One-Click™ connector cleaning tools are designed to clean a wide variety of connector & ferrule types (2.5mm, 1.25mm and MPO/MTP) either directly, or within an adaptor, all with a simple single-action cleaning system (push/release). The MPO/MTP version will clean connectors with or without pins. This handy tool is effective with a variety of contaminants and with over 500 cleaning cycles per unit it also has a low cost per clean



Description	Part Number
Cleaning Tool for MTP and MPO	200-346
Cleaning Tool for SC, ST, FC and E2000 Connectors	200-347
Cleaning Tool for LC & MU c/w UPC & APC Polisher	200-348

## Polishing Puck - Metal

### Features

- Range of metal hard wearing polishing pucks
- The connector ferrule is held perpendicular to the polishing surface
- Universal free floating pucks for 2.5mm ferrule connectors
- Free floating pucks hold ferrule only and must be held in light contact with the polishing film
- Ferrule is normally held in contact with film by connector spring pressure, however the locking pucks require the connector body to be mated with the puck
- Locking pucks are specific to a type of connector

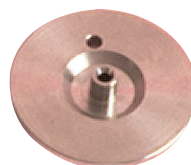

Description	Part Number
Universal Puck - FC/SC/ST	202-088
LC Polishing Puck	202-087



## Fibre Scribes



### Features

- During connector termination it cleaves the sprig of fibre
- Gently pull the fibre after using the scribe to nick the fibre as close to the ferrule as possible
- Cleave will propagate across the fibre
- Diamond and Sapphire tips available
- Pen style designs

Description	Part Number
Sapphire	202-092

## Kevlar Scissors



These general purpose scissors are suitable for trimming Kevlar or aramid yarns and for cutting light duty cables. The carbon steel blades are chrome plated and have a cutting length of 40mm.

Description	Part Number
Kevlar Scissors	202-093

## Disposal Bins



Disposal Bins should be used to store fibre ends after cleaving and general cable preparation. With sealable lid.

Description	Part Number
Disposal Bin	200-921

## Cleaning Wipes



Pre-saturated Cleaning Wipes IPA – Non abrasive lint free wipes are used to clean fibre and connectors prior to installation, pre-saturated with ISO propyl alcohol in order to eliminate problems with the transportation and use of solvents on site. Supplied in Packs of 80 individually sealed sachets.

Lint free Cleaning Wipes – Non abrasive lint free wipes are used to clean Fibre and connectors prior to installation. Supplied in boxes of 100.

Description	Part Number
Pre-saturated IPA Cleaning Wipes, Pack of 80	200-911
Lint Free Dry Cleaning Wipes, Pack of 100	200-906



Please check with your local Excel Sales Office or distributor for in country product availability

## Epoxy Syringe and Needle

Hand held needle and 3cc syringe sets, used to load connectors with epoxy prior to termination.

Description	Part Number
3cc Syringe and Needle, Pack of 5	200-903
3cc Syringe - Single	200-903-A
3cc Needle - Single	200-903-B



## Lapping Film

A complete range of high quality lapping film for connector polishing. Sheet size is 250 x 280mm.

Description	Part Number
0.3µm White Lapping Film	200-864
1.0µm Lime Green Lapping Film	200-866
3.0µm Dark Pink Lapping Film	200-868
5.0µm Brown Lapping Film	200-870
9.0µm Blue Lapping Film	200-872
12.0µm Yellow Lapping Film	200-874
30.0µm Green Lapping Film	200-876

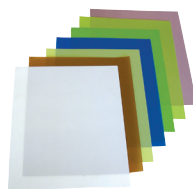

## Blanking Plugs

Blanking plugs can be used in part loaded panels to ensure a tidy and professional installation.

Description	Part Number
SC (Duplex)	200-395
LC (Duplex)	200-930



## Isopropyl Alcohol (IPA)

Isopropyl alcohol is used on lint free wipes to remove grease and dirt from optical fibres during splicing and termination. It is recommended that the fluid is decanted into fluid dispensers before use.

Please note that IPA is highly flammable and should be used only in well ventilated areas.

Description	Part Number
Isopropyl Alcohol (IPA) (1 Litre)	202-094





## Miniature Cotton Buds



Miniature cotton buds are used for cleaning in-line adaptors, connectors and other small or inaccessible areas, usually in conjunction with IPA fluid. The buds are lint free and are manufactured using pharmaceutical grade cotton. They are smaller in size than those sold commercially.

Description	Part Number
Miniature Cotton Buds (200 Pack)	202-104

## Air Duster



Quickly removes dust and debris. High pressure jet of air cleans effectively.

### Features

- CRC Cleanair

Description	Part Number
Air Duster	202-114

## Fibre Optic Warning Labels



Laser and Fibre optic warning labels for identification of fibre cables and termination points.

Description	Part Number
Fibre Optic Warning Labels	202-115

## Cleaning Wire



These wires can be used to clean debris or broken fibres from capillary holes in straight ferrules of fibre optic connectors.

### Features

- Two sizes available
- Five per bag

Description	Part Number
1.25mm 100mm length fibre cleaning wire	202-116
2.5mm 145mm length fibre cleaning wire	202-117

## Cable Glands with Strain Relief

Compression glands are used to provide strain relief for cables as they enter patch panels and wall boxes. The glands are resistant to both benzene and oil. The gland is supplied with a lock nut as standard. Cable diameters from 2.6mm to 25mm can be accommodated.



### Technical Data

**Colour:** Grey

**Temperature Range:** -30°C to +100°C

**Material:** Polyamide

**Protection Rating:** IP68

Cable Sizes (mm)	Cut Out Diameter (mm)		Part Number
2.6 – 6.5	12.5	PG7	202-095
4.0 – 10.0	18.6	PG11	202-096
6.0 – 12.0	20.4	PG13	202-097
9.0 – 14.0	22.5	PG16	202-098

## Self Adhesive Twist Clips

Kurly-Lok self adhesive cable clips are ideal for securing and routing fibre within patch panels and wall boxes. Designed with rounded edges that will not damage the fibre.

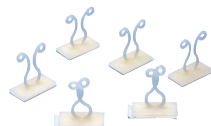

### Technical Data

**Colour:** Natural

**Material:** Nylon 6/6, RMS-01

Bundle Size	Height	Part Number
9.2mm	26.1mm	200-120

## Cold Cure Adhesive and Primer

The adhesive and the primer are supplied in separate containers. The system works by injecting adhesive into the connector. The fibre is then brushed with the primer before being inserted into the connector.



Description	Part Number
Cold Cure Adhesive and Primer	202-080

## Enbeam Launch Box



The launch box acts as an interface between the OTDR and the system under test. It allows the OTDR to see the first connector in the system, whereas without the launch box this connector would be within the OTDR's launch dead zone. Use of a launch box also helps to reduce wear and tear on the OTDR interface connector, as most couplings are made to the launch box rather than the OTDR itself.

## OVF-1 – 'Pen-size' Visual Fault Locator



The OVF-1 is specially designed for field personnel who need an efficient and economical tool for fiber tracing, fiber routing and continuity checking in an optical network during and after installation.

Fiber breaks, microbends, and poor optical splices are clearly visible as light glows through the fiber buffer or outer jacket.

Fault location behind optical connectors where the use of OTDRs is limited due to dead zones is now possible with the OVF-1.

### Features

- Rugged metal housing, pen-size format
- Lightweight
- Visible laser light at 635 nm
- Usable with single-mode and multimode fibers
- Range >5 km
- CW and blink modes
- Long battery life (>40 hours)

Description	Part Number
'Pen-size' - Visual Fault Locator	E-V-OVF-1

For prices and availability details please call our Sales Office



## Enbeam Junction Splice Box

These patch boxes and splice enclosures are manufactured from impact resistant polycarbonate and provide a cost effective means of breaking out fibres from multicore cables prior to termination or splicing. The boxes provide protection against water and dust ingress to IP65. The lids are attached using captive screws. A wide range of accessories are available.

### Features

- Cut-outs to suit any glanding configuration can be drilled on site
- The Unloaded (UL) version includes only the poly box

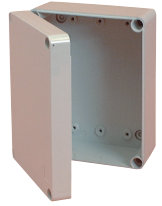

**Dimensions:**  
80mm x 170mm x 135mm

Description	Part Number
12 Fibre Junction Splice Box - Splice Kit	202-040
24 Fibre Junction Splice Box Lockable - Splice Kit	202-041

## Enbeam Junction Splice Box - Steel IP65

These patch boxes and splice enclosures are manufactured from impact resistant steel and provide a cost effective means of breaking out fibres from multicore cables prior to termination or splicing. The boxes provide protection against water and dust ingress to IP65. The lids are attached using captive screws. A wide range of accessories are available.

### Features

- Cut-outs to suit any glanding configuration can be drilled on site
- Comes with 2 PG 9 and 2 PG 21 glands
- Comes with 4 entry points



**Dimensions:**  
430mm x 330mm x 199mm

Description	Part Number
24 Fibre Steel Splice Box – Unloaded	202-120



# Excelerator Configurator

To assist you with choosing the right pre-terminated fibre cable we've developed the Excelerator Configurator that takes you through a number of simple steps to design your cable.

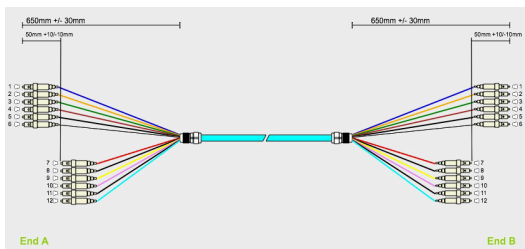

**Type**  
 Assembly  
 MTP Trunk

**Construction** **1**  
 Distribution  
 Breakout  
 Mini-Breakout

**Category**  
 OM3  OM4  OS2

**Cores**  
 8  12  16  
 24  48  72

**Connector A**  
 LC  SC

**Connector B**  
 LC  SC

**Length (m)** **1**

**Quantity**

The configurator will produce a drawing and a specification that can be sent to our sales team to obtain a quotation.

**EXCELERATOR** Pre-terminated / Pre-tested Cabling Solutions Enquiry 0 Items

**Type**  
 Assembly  
 MTP Trunk

**Construction** **1**  
 Distribution  
 Breakout  
 Mini-Breakout

**Category**  
 OM3  OM4  OS2

**Cores**  
 8  12  16  
 24  48  72

**Connector A**  
 LC  SC

**Connector B**  
 LC  SC

**Length (m)** **1**

**Quantity**

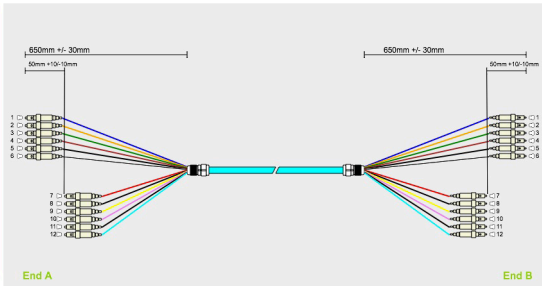

**Cable Specifications**

Construction:	Distribution	Category:	OM4	Mode:	Multimode
Cores:	12	Colour:	Aqua	Diameter:	6.2mm
Splitter:	Splitter M20*15				

**End A**

Connector:	LC x 12 pcs
Buffer:	900µm
Fanout:	650mm +/-30/-30mm
Stagger:	50mm +/-10/-10mm
Colour Key:	1: blue 2: orange 3: green 4: brown 5: slate 6: white 7: red

**End B**

Connector:	SC x 12 pcs
Buffer:	900µm
Fanout:	650mm +/-30/-30mm
Stagger:	50mm +/-10/-10mm
Colour Key:	1: blue 2: orange 3: green 4: brown 5: slate 6: white 7: red

Visit the online configurator at [excelerator.excel-networking.com](http://excelerator.excel-networking.com) to build your cable.





**Head Office**

Excel House  
Junction Six Industrial Park  
Electric Avenue  
Birmingham B6 7JJ  
England

**T:** +44 (0)121 326 7557

**E:** [sales@excel-networking.com](mailto:sales@excel-networking.com)



[www.excel-networking.com](http://www.excel-networking.com)