



Smart access control
and door entry systems

Product Selection Guide



3 Networked Access Control

Our networked access control system, Net2, is administered using one or more PCs and can be monitored and managed from a central location. Our door controllers come as IP, wireless or battery powered.

- 4 Wired Controllers - Net2 Plus
- 5 Wireless Controllers - Net2 Nano
- 6 Wireless Controllers - PaxLock Pro
- 7 PaxLock Pro Components
- 8 Wireless Controllers - Net2 PaxLock
- 9 Net2 PaxLock Components
- 10 Building Control - I/O Board
- 11 Net2 Readers
- 15 Net2 Tokens
- 17 Net2 Software
- 18 Accessories & Other Components
- 20 Demonstration Products

21 Access Control & Video Management

Our single platform solution combining access control and video management. Supporting a simple migration path from Net2, Paxton10 is an ideal solution to futureproof site security.

- 22 Paxton10
- 23 Integration
- 24 Cameras
- 25 Readers and Tokens
- 26 Software and Apps

27 Door Entry

Our door entry system, Entry, is an advanced PoE door entry system with built-in access control capabilities.

- 28 Entry System Components
- 31 Demo Cases

33 Standalone Access Control

Our standalone access control is a non-networked system made up of readers or simple door controllers located at each door. Standalone systems are administered via the use of tokens or card packs.

- 34 Switch2
- 35 Switch2 Readers
- 38 Compact
- 40 Standalone Tokens
- 41 Standalone Accessories

43 Additional Information

- 44 Distributors - Where to Buy

Welcome

This Product Selection Guide is designed to help you to choose the right products to build up an access control system.

Paxton produce a variety of security solutions to suit different site requirements. Our one door philosophy means doors can be added as required or when budget becomes available.

What's new?



Paxton10

Paxton10 is a single platform solution combining access control and video management. It is a versatile solution that supports multi-site management and remote access. Scalable from 1 to 1000 doors, and 1 to 1000 cameras, Paxton10 is suitable for all building types and sizes.

- ▶ Easy to quote and configure, build a complete system with just five components
- ▶ Manage multiple sites on a single system remotely
- ▶ Web-based user interface with no configuration required
- ▶ Custom dashboards to suit any user requirements
- ▶ Built in **Bluetooth®** to use phone or smart watch smart credentials
- ▶ Works with Entry and PaxLock Pro

See page 21

Networked Access Control

Our networked access control system, Net2, is administered using one or more PCs and can be monitored and managed from a central location. Our door controllers come as IP, wireless or battery powered.

- ▶ Net2 is Paxton's flagship access control product
- ▶ A powerful networked system that addresses the needs of the mid-market
- ▶ Modular approach for simplicity and scalability
- ▶ Simple intuitive software
- ▶ Range of features that move beyond basic access control
- ▶ A complete solution that encompasses wireless and door entry



Net2 plus Wired Controller

- ▶ A networked IP ready single door controller
- ▶ On-board TCP/IP connection allows direct connection to a network
- ▶ Can connect together with dedicated RS485 network

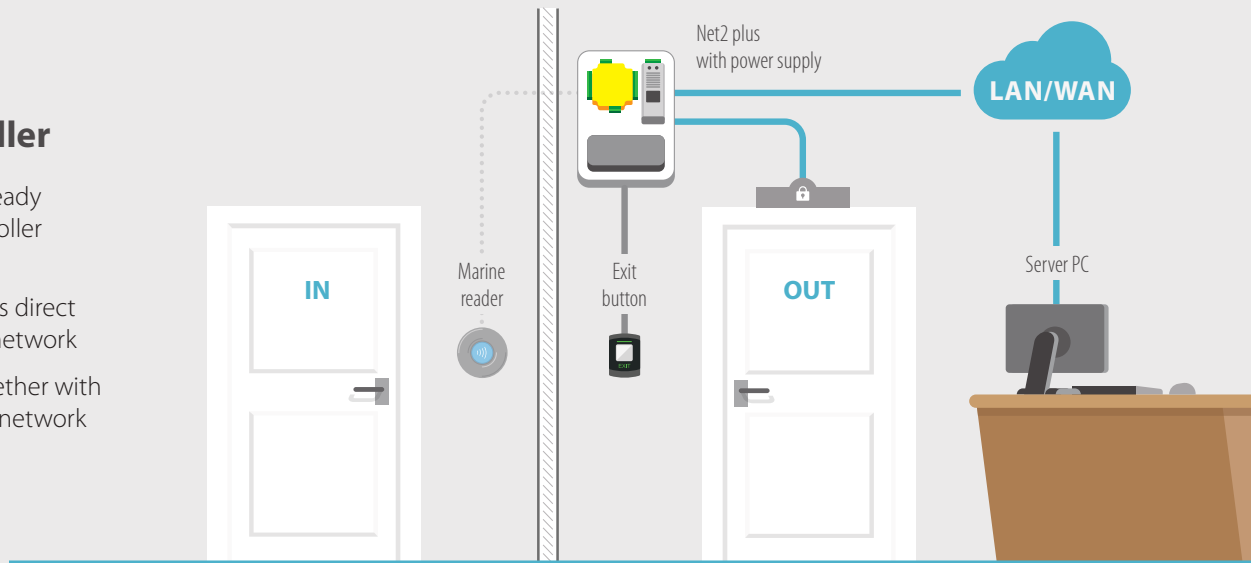

Net2 plus 1 door controller

BEST SELLER

Sales code 682-493 Price £305.00

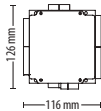

Net2 plus 1 door controller -
Plastic housing

Sales code 682-528 Price £320.00

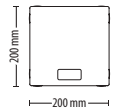

Net2 plus 1 door controller -
12V 2A PSU, Plastic cabinet

BEST SELLER

Sales code 682-531 Price £390.00

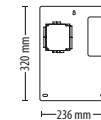

Net2 plus 1 door controller -
12V 2A PSU, Metal cabinet

Sales code 682-813 Price £400.00

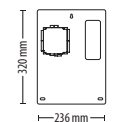

Net2 plus 1 door controller -
PoE+, Plastic cabinet

Sales code 682-284 Price £390.00

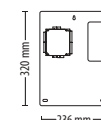

Net2 plus 1 door controller -
PoE+, Metal cabinet

Sales code 682-721 Price £405.00

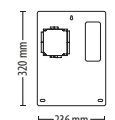

Net2 nano Wireless Controller

- ▶ A wireless single door controller
- ▶ Communicates to the server using Net2Air technology via a Net2Air Bridge
- ▶ No cable required between Net2 nano and the server PC, reducing installation time

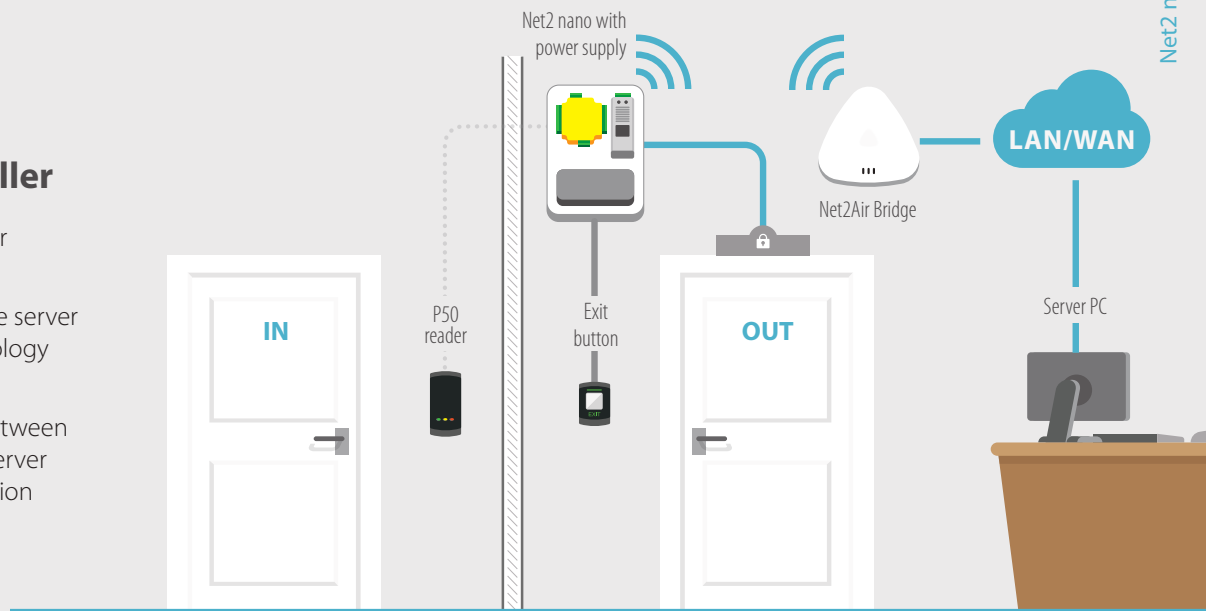

Net2 nano 1 door controller - 12V
2A PSU, Plastic cabinet

Sales code 654-772 Price £275.00

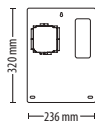

Net2Air Bridge

UPDATED

Sales code 477-600 Price £180.00

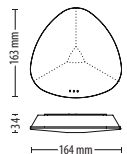

Product tutorials

We have a series of Net2 software tutorial videos available, they illustrate how you can get the very best from the Net2 software, and offer your customers more from their access control system.

Watch them here:
<http://paxton.info/3017>

- ▶ Anti-passback
- ▶ Landlord Tenant
- ▶ Security Lockdown
- ▶ CCTV, Fire and Intruder alarm integration
- ▶ and more...

PaxLock Pro Wireless Controller

- ▶ Standalone or networked
- ▶ Simple upgrade path from standalone to networked
- ▶ Dual-frequency proximity reader
- ▶ EN179 Certified for emergency exits
- ▶ FD30 and FD60 certified for fire doors
- ▶ Compatible with DIN standard locks

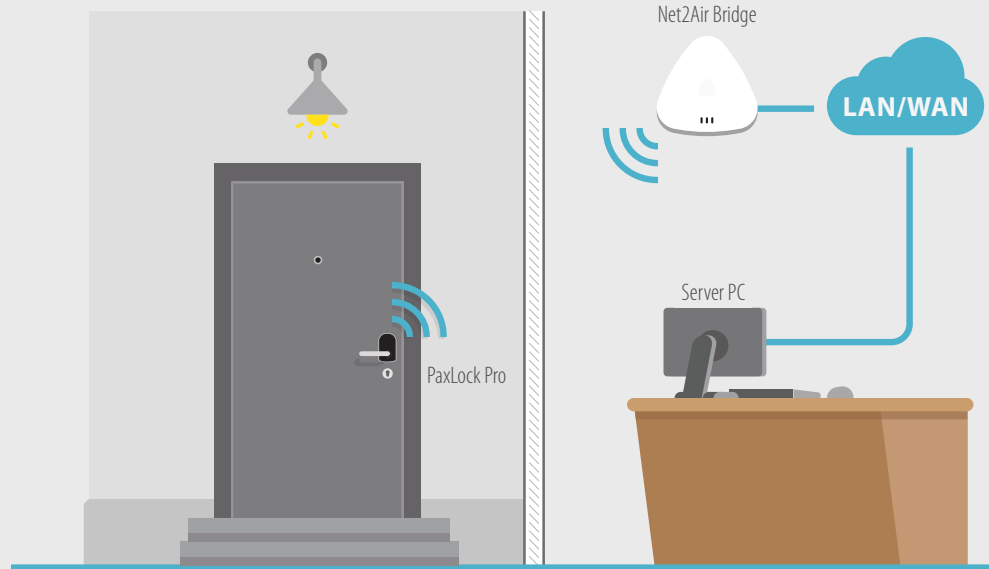

PaxLock Pro - Euro, Internal, White

Sales code Price
900-100WT £380.00

PaxLock Pro - Euro, Internal, Black

Sales code Price
900-100BL £380.00

PaxLock Pro - Euro, External, White

Sales code Price
900-200WT £415.00

PaxLock Pro - Euro, External, Black

Sales code Price
900-200BL £415.00

Net2Air Bridge

In response to your feedback, the Net2Air Bridge has been redesigned, with a low profile which can be wall or ceiling mounted for a quick and simple installation.



More about it here:
<http://paxton.info/1387>

Sales code Price
477-600 £180.00



PaxLock Pro - Euro DIN18251 door installation jig

Sales code Price
900-080 £60.00

Please note: It is recommended that PaxLock Pro is installed with a lockset with key override to ensure access can be gained in the rare event of a unit failure.

PaxLock Pro Components

These products may be used with PaxLock Pro to aid installation on a variety of doors.

► <http://paxton.info/3566>



PaxLock - Mortice sash lock, 72mm centre

Sales code	Price
901-010	£25.00

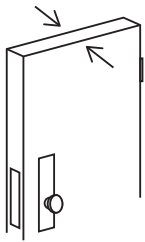
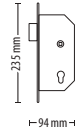

50-54mm door kit

Sales code	Price
900-059	£20.00

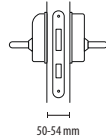

57-60mm door kit

Sales code	Price
900-060	£20.00

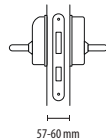

<http://paxton.info/3566>



PaxLock - Mortice latch

Sales code	Price
901-020	£25.00

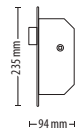

9mm spindle kit

Sales code	Price
900-071	£12.00



8mm split spindle

Sales code	Price
901-016	£12.50



PaxLock Pro - Euro, EN179 kit



Sales code	Price
901-015	£50.00

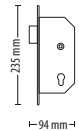

Cover Plate Kits:

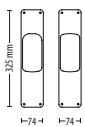

Euro blank

Sales code	Price
900-051	£43.00

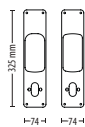

Euro profile, 90-92mm

Sales code	Price
900-054	£50.00

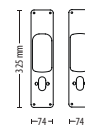

Euro profile, 70-72mm

Sales code	Price
900-053	£50.00

Demo case PaxLock Pro

The demo case comes with everything you need to show your customers the PaxLock Pro in action.

- Demo Stand with EN179 escape sash lock
- White External PaxLock Pro
- Standalone Token pack (x2 Tokens)
- Batteries

Sales code	Price
900-900	£300.00



Net2 PaxLock Wireless Controller

- ▶ Networked access control system in a wireless door handle
- ▶ Fits a standard Euro lock case for quick installation
- ▶ Integrates with Net2 access control
- ▶ Communicates using Net2Air technology

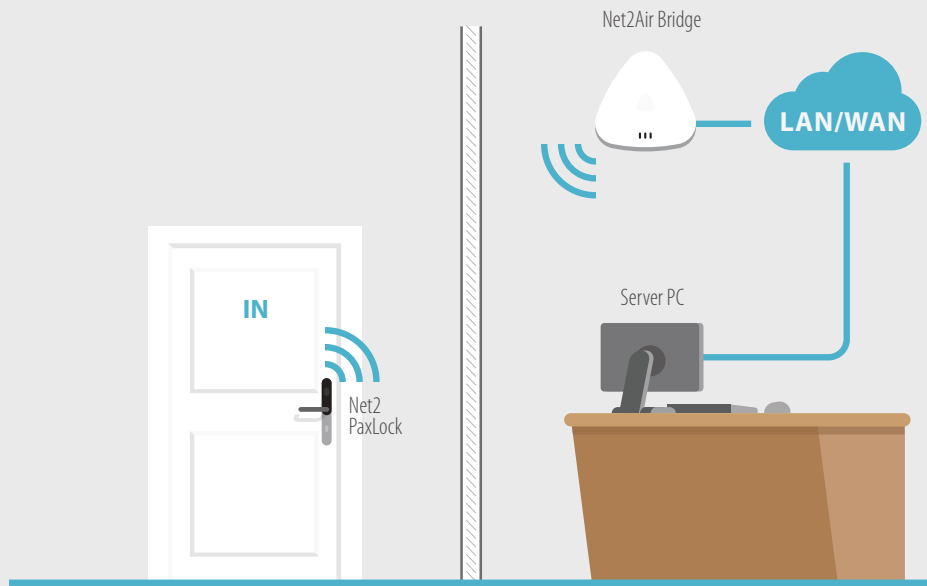

Net2 PaxLock Euro - 72mm

Sales code 901-172 Price £325.00 **BEST SELLER**

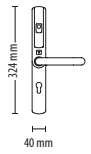

Net2 PaxLock Euro - 48mm

Sales code 901-148 Price £325.00

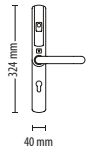

Net2 PaxLock No key override

Sales code 901-110 Price £325.00

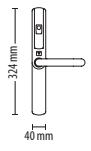

Net2 PaxLock MIFARE® - 72mm Euro

Sales code 901-272 Price £325.00 **BEST SELLER**

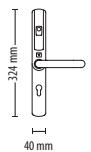

Net2 PaxLock MIFARE® - 48mm Euro

Sales code 901-248 Price £325.00

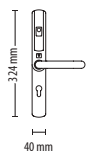

Net2 PaxLock MIFARE® - No key override

Sales code 901-210 Price £325.00

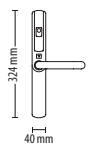

Net2 PaxLock Components

These products may be used with Net2 PaxLock to aid installation on a variety of doors.



Net2Air Bridge

UPDATED

Sales code Price
477-600 £180.00

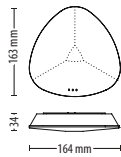

PaxLock - Mortice sash lock, 72mm centre

Sales code Price
901-010 £25.00



Net2 PaxLock cover plate - Set of 2

Sales code Price
901-060 £25.00

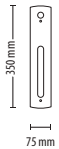

PaxLock - Mortice latch

Sales code Price
901-020 £25.00



Net2 PaxLock blank inner handle cover - Pack of 5

Sales code Price
901-050 £25.00



PaxLock Mortice escape sash lock - 72mm centre

Sales code Price
901-030 £60.00



Net2 PaxLock Split spindle - 8mm

Sales code Price
901-035 £12.50

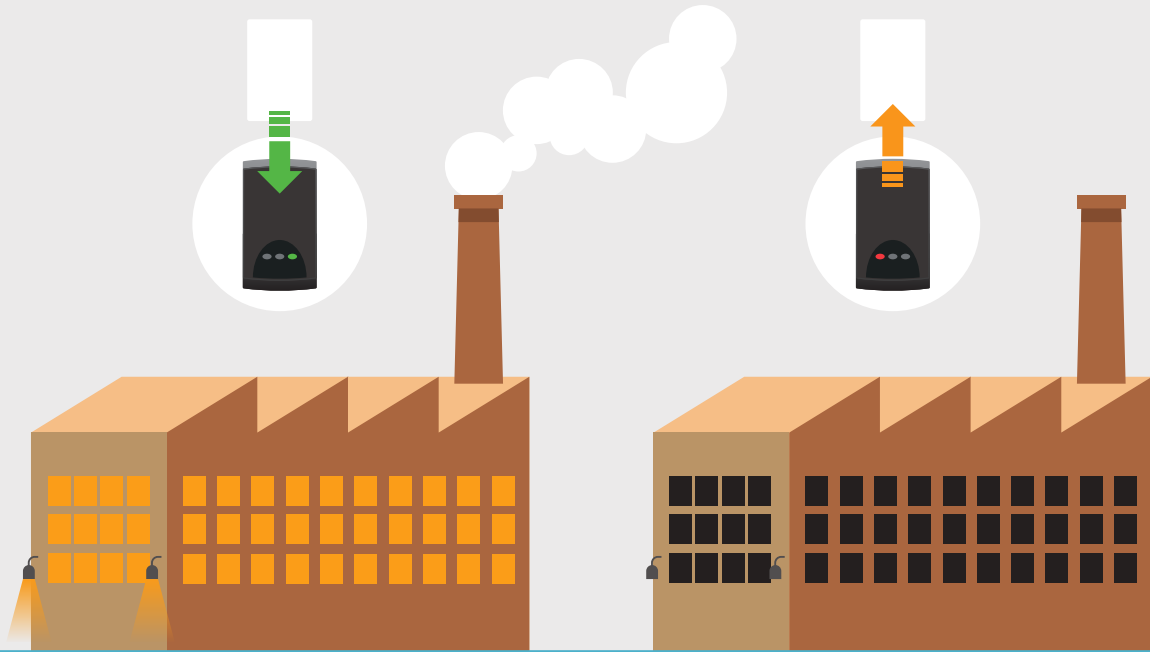

Building Control - I/O Board

When a valid fob is presented to the reader, the I/O board can be programmed to trigger the power to lighting, heating and electrical equipment.

The Net2 I/O board is a simple, yet powerful addition to the Net2 system. It can be wired alongside a Net2 door controller, to switch power on and off to electrical equipment to save money and energy. The Net2 I/O board can control power to lifts, lighting, heating, water and air-conditioning by using the Triggers and Actions application in the Net2 software. These actions can be programmed for a particular time, or in response to a specific Net2 event.

- ▶ Connect directly to a LAN/WAN only
- ▶ Enable integration with lifts, lighting, heating and more
- ▶ 4 inputs and 4 outputs on the Net2 I/O board

 Please note, Net2 I/O boards work as part of the Net2 system. They are not door controllers.



Net2 I/O board

Sales code 489-710 Price £245.00

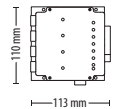

Net2 I/O board - Plastic housing

Sales code 385-710 Price £260.00

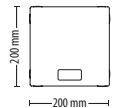

Net2 I/O board - 12V 2A PSU, Plastic cabinet

Sales code 411-623 Price £320.00

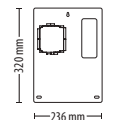



* Indicates readers that have functionality to read HID™ 125kHz Proximity tokens, using Genuine HID Technology™ 125kHz. This is enabled using Genuine HID Technology™ Proximity activation licence cards or Wiegand activation licence cards (if the reader needs to provide a Wiegand output), both sold separately (see Tokens section, pg., [pg.14](#)).

Net2 Readers

These readers are for use with Net2. Designed to fit in seamlessly in any environment, our wide range means you get the right choice for your site requirements.



Proximity reader - P38

Sales code Price
333-110 £120.00



Proximity reader - P50 **BEST SELLER**

Sales code Price
353-110 £120.00

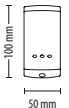

Proximity reader - P75

Sales code Price
373-110 £120.00

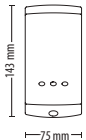

Proximity reader - P75, Screw connector

Sales code Price
373-120 £120.00

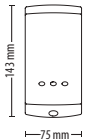



* Proximity reader - P200

Sales code Price
323-110 £130.00





* Proximity reader - P200, Metal mount

Sales code Price
324-110 £130.00







* Proximity metal reader - Satin chrome

BEST SELLER

Sales code Price
390-747 £170.00





* Proximity metal reader - Chrome

Sales code Price
390-727 £170.00



Networked Access Control



Proximity vandal proof reader



Sales code 568-855 Price £150.00

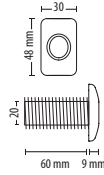

Proximity panel mount reader



Sales code 390-135 Price £150.00



Proximity marine reader



Sales code 500-010 Price £225.00

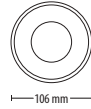

Proximity energy saving reader



Sales code 595-248 Price £125.00

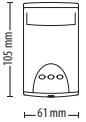

Proximity long range reader



Sales code 313-110 Price £285.00

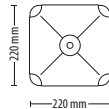

Net2 proximity MIFARE® reader - P50



Sales code 353-467 Price £130.00

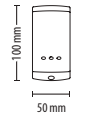

Proximity backbox reader - MIFARE®



Sales code 371-125 Price £160.00

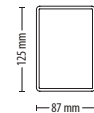

Proximity backbox reader - Black or White



Sales code 370-225BL/WT Price £150.00

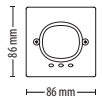

Proximity architectural reader - Matt black, gunmetal grey or satin chrome



Sales code 360-864BL/GG/SC Price £240.00



Insert - Stone



Sales code 361-002 Price £60.00

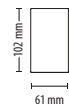

Insert - Glass with logo



Sales code 361-003 Price £60.00





CARDLOCK reader - Satin chrome

Sales code 409-711SC Price £125.00

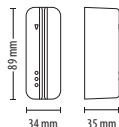

Net2 proximity mullion reader



Sales code 345-220 Price £115.00

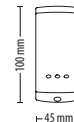

Proximity universal reader - Clock and data

Sales code 339-111 Price £180.00



TOUCHLOCK vandal resistant metal keypad

Sales code 521-715 Price £130.00

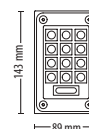

Proximity keypad - KP50

Sales code 355-110 Price £140.00

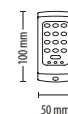

Proximity keypad - KP75

Sales code 375-110 Price £140.00

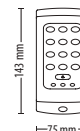

Proximity keypad - KP75, Screw connector

Sales code 375-120 Price £140.00

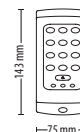

TOUCHLOCK keypad - K50

Sales code 351-110 Price £45.00



TOUCHLOCK keypad - K75

Sales code 371-110 Price £45.00

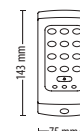



TOUCHLOCK stainless steel keypad
- K50

Sales code Price
352-110 £80.00

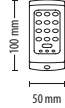

TOUCHLOCK stainless steel keypad
- K75

Sales code Price
372-110 £80.00

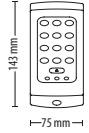

Proximity metal keypad, MIFARE® -
KP75

Sales code Price
375-130 £135.00

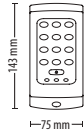

Net2 caller ID reader - Plastic
housing

Sales code Price
460-210 £375.00

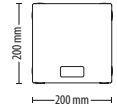

Top 5 Markets for Access Control

Increase your revenue by selling to a wider range of markets where access control is the ideal solution.

Net2 system can be adapted to meet a range of diverse requirements. The top five markets we recommend commissioning and installing, include:

- ▶ Healthcare
- ▶ Education
- ▶ Retail
- ▶ Leisure
- ▶ Commercial

See our latest case studies here:
<http://paxton.info/3016>

Net2 Tokens

These tokens are for use with Net2 systems.

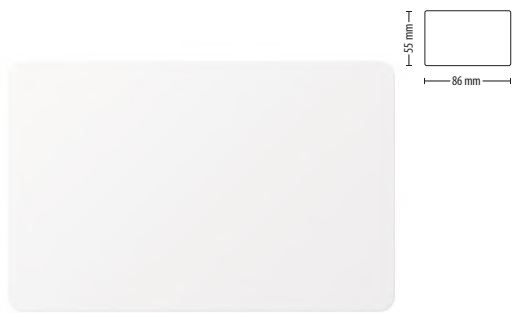

Net2 proximity ISO cards -
Without magstripe

x10

Sales code 692-500 Price £38.00

x500

Sales code 692-052 Price £1595.00



Net2 proximity ISO cards -
With magstripe

x10

Sales code 692-448 Price £38.00

x500

Sales code 692-053 Price £1595.00



MIFARE® Classic 1k ISO card -
Without magstripe

x10

Sales code 692-148 Price £38.00

x500

Sales code 692-152 Price £1595.00



Net2 magstripe cards -
Pack of 10

Sales code 695-573 Price £25.00



Net2 proximity clamshell cards -
Pack of 10

Sales code 693-112 Price £55.00



Net2 proximity keyfobs - Pack of 10

Sales code 695-644 Price £38.00

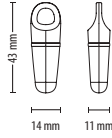

Net2 hands free keyfob

Sales code 690-222 Price £35.00

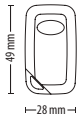

Net2 hands free keycard

Sales code 690-333 Price £40.00

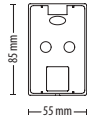

MIFARE Classic® 4K keyfob - Pack of 10

Sales code 695-150 Price £35.00

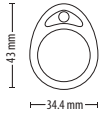

Net2 Watchprox - Black or Silver, Pack of 10

Sales code 698-574BL/SL Price £30.00

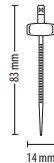

Net2 proximity self adhesive disc - Pack of 10

Sales code 660-100 Price £35.00



Genuine HID Technology™ Licence Activation Cards

125Khz ISO Proximity Card Licence with Genuine HID Technology™



x1

Sales code 125-001 Price £25.00



x5

Sales code 125-005 Price £125.00



x10

Sales code 125-010 Price £250.00

Wiegand Activation Card with Genuine HID Technology™



Sales code 125-201 Price £45.00

Genuine HID Technology™ 125kHz Proximity activation licence cards and Wiegand activation licence cards are for use with Net2 readers indicated with the symbol ✨ (from pg. 9) to activate functionality to read HID™ 125kHz Proximity or HID™ Wiegand tokens.



Net2 Software

Net2 Pro has all the capabilities of Net2 Lite software with advanced features like timesheet and timeline, Landlord Tenant, security lockdown and anti-passback. Net2 Pro also includes a number of new features to support COVID-secure sites.

Net2 Lite contains all of the access control features to manage access privileges and report on users. Other features include multiple workstations, CCTV and intruder alarm integration and site graphics.



Feature	Lite	Pro
Multiple clients	•	•
Free upgrades	•	•
CCTV integration	•	•
Site graphics	•	•
Triggers and actions	•	•
Intruder alarm integration*	•	•
Entry compatible	•	•
Biometric integration	•	•
Landlord Tenant	-	•
Timesheet & Timeline*	-	•
Card designer	-	•
Roll call and muster reporting*	-	•
Fire alarm integration*	-	•
Anti-passback*	-	•
Security lockdown*	-	•
Multi-zone intruder alarm integration*	-	•
Custom days*	-	•
Areas	-	•
Customisable welcome page	-	•
Paxton Connect app**	-	•
Net2Online**	-	•
Checkpoint Control	-	•
Occupancy Management	-	•

* Not available with wireless products

** Paxton Connect app only works with Net2 Pro v6.00 or above

*** Net2Online only works with Net2 Pro v6.01 or above

Watch our tutorial videos and learn how you can get the very best from the Net2 software and offer your customers more from their access control system.

<https://paxton.info/3018>



Net2 software - Pro

Sales code 930-010 Price £550.00

Net2|Lite

Net2 software - Lite

Download only



NEW Net2Online and Paxton Connect

Easy access to your Net2 system wherever you are – any location, any device. Flexible site management via a browser with Net2Online and from the Paxton Connect app.

Features include:

- ▶ User admin
- ▶ Managing roll call reports
- ▶ Open door functionality
- ▶ Viewing reports and events
- ▶ Free with Net2 Pro

Download the app now:



Net2 Accessories & Other Components



Net2 desktop reader - USB

Sales code Price
514-326 £60.00

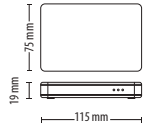

Net2 desktop reader - Proximity and magstripe

Sales code Price
350-910 £80.00

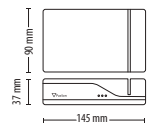

Proximity hands free interface - Plastic housing

Sales code Price
477-222 £110.00



Paxton 12V 1A DC power supply - Plastic housing

Sales code Price
998-241 £35.00

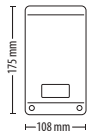

2A/12V DC power supply - no housing

Sales code Price
857-090 £75.00

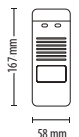

Paxton reader port connector - Pack of 5

Sales code Price
325-030 £32.00



Paxton 12V 2A DC power supply - Plastic cabinet

Sales code Price
857-250 £95.00

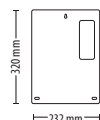

Single port midspan 802.3at PoE injector

Sales code Price
477-400 £60.00

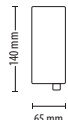



Paxton exit button - E50

Sales code 356-310 Price £32.00



Paxton exit button - E75

Sales code 376-310 Price £32.00

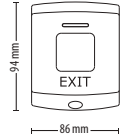

Paxton marine exit button

Sales code 593-721 Price £110.00

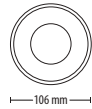

Paxton UK backbox adaptor - 75 series

Sales code 310-750 Price £6.50

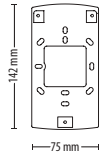

Proximity hands free card holders - Suckers, Pack of 5

Sales code 696-100 Price £15.00

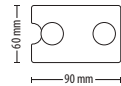

Proximity ISO card holder - Clear, Pack of 5

Sales code 696-400 Price £5.00

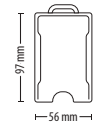

Paxton reader cable - 10 core, CR9540, 100m reel

Sales code 166-100 Price £100.00



Reader Cable - Halogen Free 10 Core - 100m

Sales code 166-110 Price £141.79



Proximity reader clip on cover 50mm - in and out

Sales code 310-300 Price £15.00

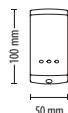

Easyprox battery pack - 4 x AA high capacity

Sales code 746-003 Price £10.00

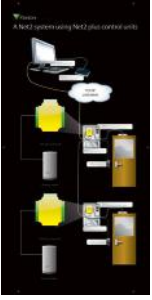

Net2 demo board -
Net2 plus

Sales code	Price
121-005	£245.00

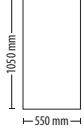

Paxton commissioning -
1 day

Sales code	Price
227-356	£550.00

Demo case Net2 plus demo case

The case Includes a Net2 plus, Net2 Pro software, Net2 desktop reader and a sample pack of Net2 demonstration tokens.

Sales code	Price
541-427	£249.00

* one demo case per customer



Access Control and Video Management

Paxton10 is a single platform solution combining access control and video management. Scalable from 1 to 1000 doors, and 1 to 1000 cameras, Paxton10 is a versatile solution suitable for all building types and sizes.

- ▶ Easy to quote and configure, build a complete system with just five components
- ▶ Manage multiple sites on a single system from anywhere with an internet connection
- ▶ Web-based user interface with no configuration required
- ▶ A range of cameras available as well as being compatible with third-party IP video cameras.
- ▶ Custom dashboards to suit any user requirements
- ▶ Built in **Bluetooth®** to use phone or smartwatch smart credentials.
- ▶ Works seamlessly with Entry and PaxLock Pro



Paxton10 Access control. Video management. One system

- ▶ Single door controller architecture for ease of install and flexibility
- ▶ Feature rich video management solution embedded in the cameras, no third-party integration required
- ▶ Built-in Bluetooth® wireless technology, supports free of charge smart credentials
- ▶ Fully compatible with Entry, our award-winning video and audio door entry solution
- ▶ Fully compatible with PaxLock, our wireless door handle range
- ▶ Distributed intelligence to increase reliability
- ▶ Powerful multiformat readers and keypad, reads Paxton, MIFARE®, HID™ Prox, EM, FeliCa, NFC and DESFire token technology

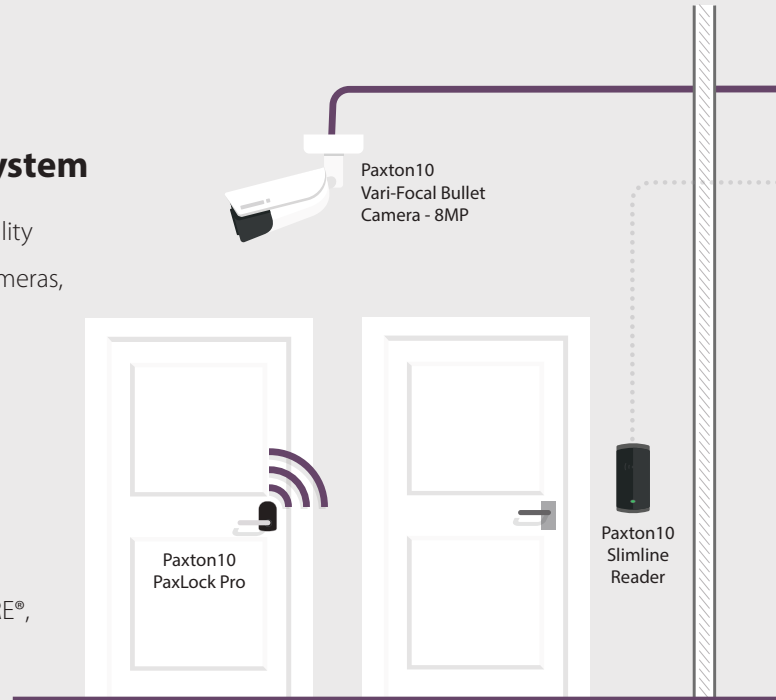

Paxton10
Door Controller

Sales code Price
010-403 £305.00

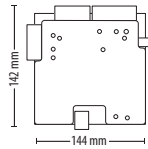

Paxton10
Video Controller - 12V 4A PSU

Sales code Price
010-187 £495.00

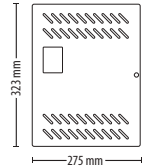

Paxton10
Door Controller - 12V 2A PSU

Sales code Price
010-751 £390.00

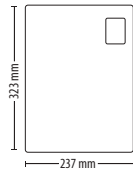

Paxton10
Video Controller - PoE

Sales code Price
010-907 £495.00

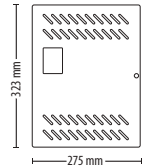

Paxton10
Door Controller - PoE

Sales code Price
010-052 £390.00

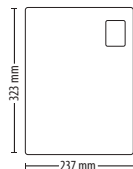

Paxton10
Server

Sales code Price
003-375 £950.00

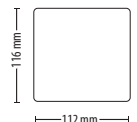

The Paxton10 Server is an Intel manufactured product and is therefore not covered by the Paxton 5-year guarantee. Paxton supports a 3-year warranty for this product, as supplied by Intel.

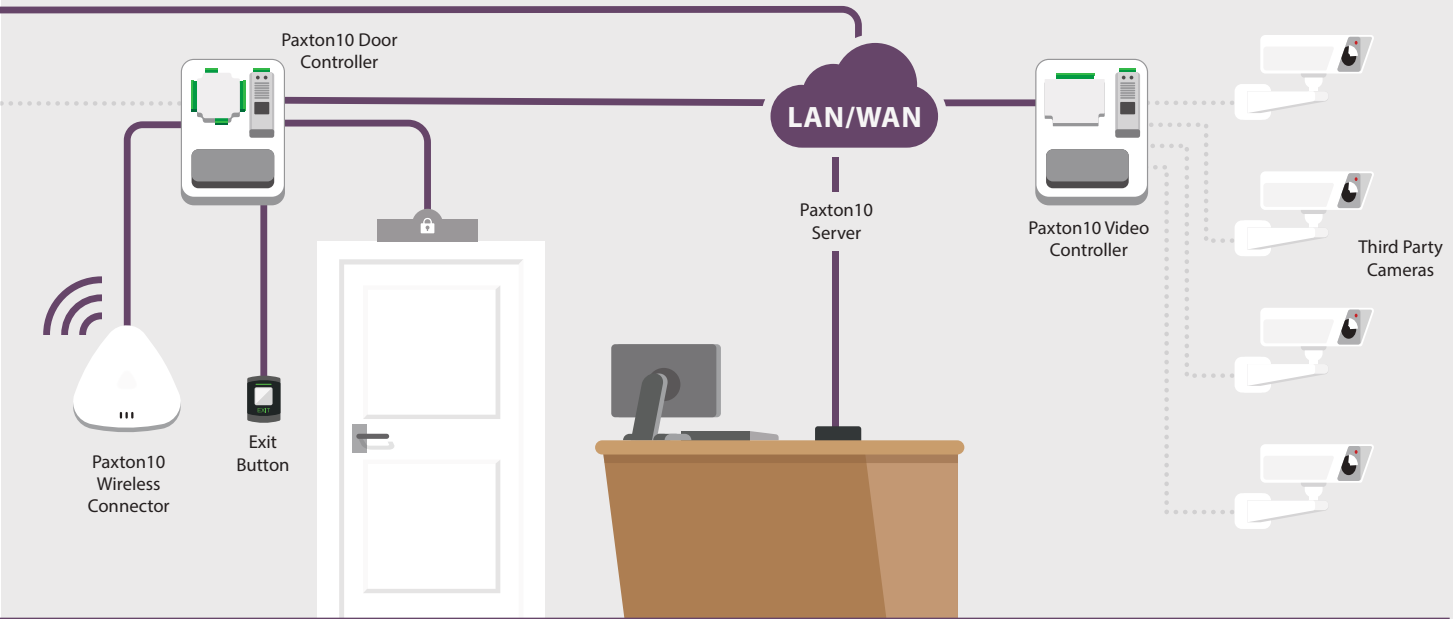

Integration

Paxton10 integrates with fire and intruder alarms to simplify building management.

You can see a list of all the available integrations for Paxton10 at paxton.info/4969



Paxton10 Alarm Connector

Sales code 010-203 Price £85.00

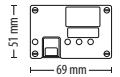

Paxton10 Reader Converter

Sales code 010-552 Price £29.00



Paxton10 Wireless Connector

Sales code 010-687 Price £150.00

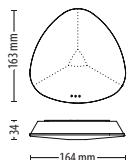

Paxton10 Desktop Reader

Sales code 010-387 Price £135.00

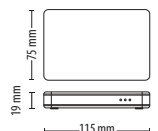

Access Control and Video Management

INTRODUCING...

Paxton10 Cameras

Paxton10 includes Paxton's own video management solution and range of cameras, providing a single point of management for system users. A Paxton10 system can manage up to 1000 cameras including integration with third party IP cameras.

- ▶ Vari-focal and mini (2.8mm) options available
- ▶ Industry leading low light performance (0.01 Lux)
- ▶ 8MP 4K resolution for crystal clear recording
- ▶ IP67 rated for internal and external use
- ▶ IK10 rated robust metal construction
- ▶ 128GB surveillance quality on camera storage included
- ▶ Edge and centralised recording capability
- ▶ Simple configuration



Paxton10 Vari-Focal Bullet Camera - 8MP

Sales code	Price
010-029	£425.00

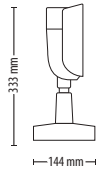

Paxton10 Vari-Focal Dome Camera - 8MP

Sales code	Price
010-075	£425.00

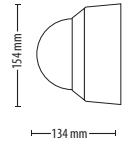

Paxton10 Mini Bullet Camera - 2.8mm, 8MP

Sales code	Price
010-372	£265.00

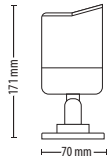

Paxton10 Mini Dome Camera - 2.8mm 8MP

Sales code	Price
010-517	£265.00

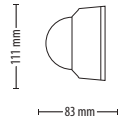

Paxton10 Mini Bullet Camera Junction Box

Sales code	Price
010-373	£16.00

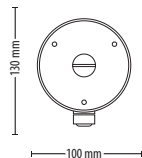

Paxton10 Mini Dome Camera Junction Box

Sales code	Price
010-518	£16.00

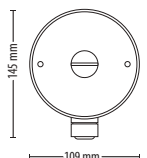

The Paxton10 cameras come with a 128GB SD card as standard. Please note, the SD card is a consumable item and is therefore excluded from the guarantee.



Paxton10 Keypad Reader

Sales code Price
010-824 £165.00

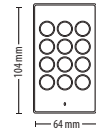

Paxton10 Keyfobs - Pack of 10

Sales code Price
010-170 £38.00

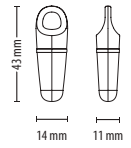

Paxton10 Vandal Resistant Reader

Sales code Price
010-254 £175.00

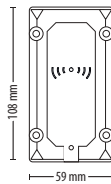

Paxton10 Bluetooth® Hands Free Keyfob

Sales code Price
010-690 £35.00

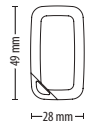

Paxton10 Slimline Reader

Sales code Price
010-296 £145.00

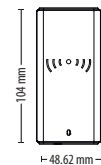

Paxton10 Cards - Pack of 10

Sales code Price
010-427 £38.00

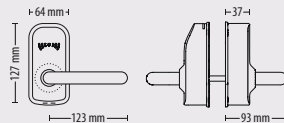
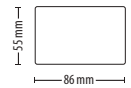

Paxton10 PaxLock Pro - Euro, Internal, White

Sales code Price
010-603WT £380.00

Paxton10 PaxLock Pro - Euro, Internal, Black

Sales code Price
010-603BL £380.00

Paxton10 PaxLock Pro - Euro, External, White

Sales code Price
010-602WT £415.00

Paxton10 PaxLock Pro - Euro, External, Black

Sales code Price
010-602BL £415.00



Paxton Connect



Paxton Key App

Paxton10 Software

A web-based user interface that is intuitive and easy to use.

Accessible from any device with an internet connection, the interface makes remote site management simple. The software comes as a native part of the system with a Paxton10 server. It has a range of intelligent features to maximise efficiency and optimise the combined access and video management solution.

- ▶ Web-based software – no installation, plug-ins or upgrading required
- ▶ Free of charge – simple online updates with no ongoing charges
- ▶ Suitable for touchscreen and desktop devices
- ▶ Optimised for use on PCs and tablets
- ▶ Low battery alerts, easy to monitor back up battery state
- ▶ Flexible and secure remote access

Features:

Dashboards - Customised dashboards to suit any user requirements

Reports - Powerful reporting engine where all system events and videos can be reviewed

Site plans - For the visual management of the system

Tutorial wizards - Support new and existing users to make full use of the software

People - Manage user permissions, credentials and information

Rules - Set permissions, time profiles, triggers and actions and much more

Devices - Configure and manage the devices in a building

Paxton10 Apps

Paxton Connect

Flexible site management

The Paxton Connect app provides easy and flexible site management for Paxton10. Containing easy to use features in one smart user interface, Paxton Connect enables you and your customers to manage multiple sites remotely from a smartphone.

Features:

People - Manage user permission, credentials and information

Reports - Access all system reports from your smart device or tablet

Devices - Configure and manage all devices on site

Dashboards - Access custom dashboards for personalised system overview

Paxton Key

Utilise smart devices as access tokens

The Paxton Key app allows system users to make use of their smartphone, smartwatch or tablet in place of traditional tokens. These are called smart credentials and can be issued free of charge. Utilising the built-in Bluetooth® wireless technology in Paxton10 readers, the smart device can securely communicate with the Paxton10 system to grant or deny access. Paxton Key also enables the user to carry out predefined building management functionality – such as setting the intruder alarm.

Download the free apps from the **App Store** or **Google Play**



Door Entry

The Entry system works standalone or alongside Net2 or Paxton10 to combine door entry with access control. Entry is a scalable solution, allowing expansion of up to a hundred panels and a thousand monitors.

- ▶ Just three components - monitor, panel and door controller
- ▶ Premium, standard, audio, and vandal resistant solutions available
- ▶ Intruder alarm integration - set the alarm in Net2 from the Entry panel for extra convenience
- ▶ Pan/tilt camera functionality to capture an angled view
- ▶ Low light sensitivity camera - ideal for use day or night
- ▶ SIP compatibility - the door can be answered from smartphone, tablet or PC
- ▶ Add a secondary IP camera for higher security sites



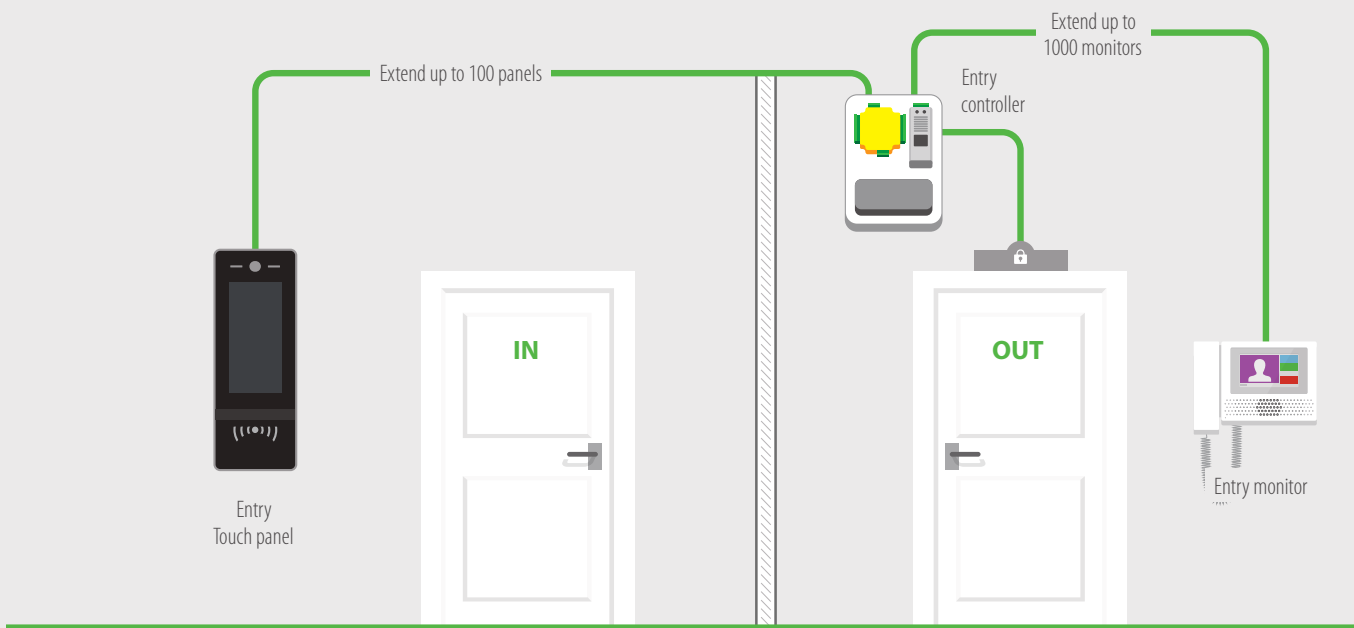

Entry

A smart, simple door entry system.

- ▶ Panels available in three variants: the Entry Touch panel with an advanced 7-inch colour touch screen, Entry Standard panel in anthracite grey and the Entry VR panel in super durable stainless steel
- ▶ All variants available in flush, surface and rain-hood versions - suitable for a range of environments
- ▶ Three monitors available, including premium, standard and audio, to create a custom solution for any site
- ▶ Personalise the Entry Touch panel, Premium monitor and Standard monitor with multiple theme options and contact images for quick visual recognition
- ▶ Video voicemail, enables visitors to leave a video message
- ▶ Add a secondary IP camera for higher security sites
- ▶ Reads Paxton and MIFARE® token technology



* Indicates readers that have functionality to read HID™ 125kHz Proximity tokens, when enabled using Genuine HID Technology™ 125kHz. Proximity activation licence cards sold separately (see Tokens section, pg.14).



Entry - Touch panel, surface mount

Sales code 337-620 Price £1495.00

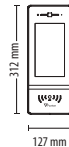

Entry - Touch panel, flush mount

Sales code 337-600 Price £1495.00



Entry - Touch panel, surface mount with rain hood

Sales code 337-610 Price £1495.00

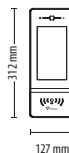



Entry -
VR panel, surface mount

Sales code Price
337-520 £895.00

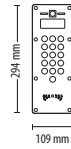

Entry -
Standard panel, surface mount

Sales code Price
337-420 £595.00

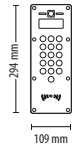

Entry -
VR panel, flush mount

Sales code Price
337-500 £895.00

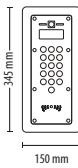

Entry -
Standard panel, flush mount

Sales code Price
337-400 £595.00

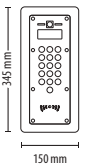

Entry - VR panel,
surface mount with rain hood

Sales code Price
337-510 £895.00

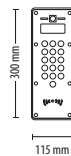

Entry - Standard panel,
surface mount with rain hood

Sales code Price
337-410 £595.00

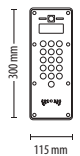

Entry Premium monitor



Sales code Price
337-290 £580.00

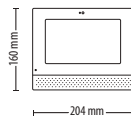

Entry Premium monitor - handset



Sales code Price
337-292 £599.00

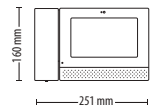

Entry desktop stand



Sales code Price
337-294 £45.00

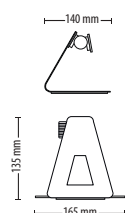



Entry Standard monitor

NEW

Sales code 337-280 Price £250.00

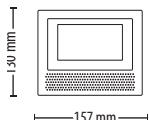

Entry Standard monitor - with handset

NEW

Sales code 337-282 Price £270.00

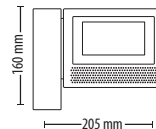

Entry Audio monitor

Sales code 337-270 Price £120.00

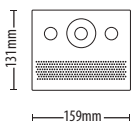

Entry Audio monitor - with handset

Sales code 337-272 Price £135.00

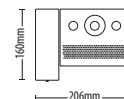

Net2 Entry - Control unit

Sales code 337-727 Price £390.00

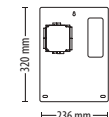

Entry - Extension switch

Sales code 337-773 Price £150.00

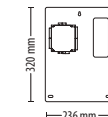

NEW

Entry Standard Monitor

The latest addition to our door entry range. The new standard monitor is fully compatible with Paxton10 and Net2, as well as working as part of a standalone door entry solution.

- Excellent audio quality, full-duplex voice communication & easy read, high contrast screen
- Personalised experience with 14 theme designs. Premium user interface with call & event log
- Action buttons, call snapshot and compatibility with concierge management*
- Available with or without a handset. Universal wall or desk mounting
- Quick and easy installation, providing a true plug and play solution



*When used with the Entry Premium monitor. The standard monitor cannot function as the concierge monitor.

Demo Cases

Demo cases contain everything you need to demonstrate a one door system to your customers.

Additionally, show your customers the benefits of our simple video door entry solution in just two minutes, with the new Entry video. Watch it here: <http://paxton.info/3019>

* Indicates readers that have functionality to read HID™ 125kHz Proximity tokens, when enabled using Genuine HID Technology™ 125kHz. Proximity activation licence cards sold separately (see Tokens section, [pg.14](#)).



Demo case * Entry - Touch panel

The case includes a Entry Touch panel, Entry Premium monitor and a sample pack of Net2 demonstration tokens.

Sales code	Price
337-635	£895.00



Demo case * Entry - Standard panel

The case includes a Entry Standard panel, Entry Standard monitor and a sample pack of Net2 demonstration tokens.

Sales code	Price
337-430	£495.00



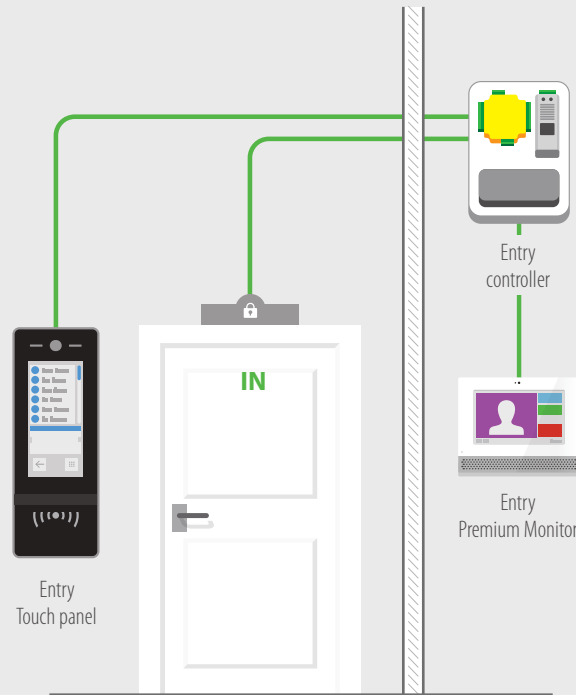

Standalone Entry system does not require connection to a network or server

NEW Entry now works Standalone

Our video door entry system now works in standalone mode for a quick, simple installation and easy user management with our standard enrolment and shadow cards. Offer a flexible system that can grow in line with your customers' requirements and be upgraded to an online Net2 solution, with no hidden costs.

- Enable offline token-based access control on any Entry site
- Simple user management utilising Paxton's standalone functionality
- Upgrade existing standalone sites with video door entry for extra convenience
- Combine with other Paxton standalone products to build an entire easy-to-use system supporting the same tokens across the site
- See Standalone card packs on [page 40](#)

Watch the New Entry Video



Show your customers the benefits of our simple video door entry solution in just two minutes, with the new Entry video.

- ▶ Featuring the whole Entry range, including the new touch panel and premium monitor
- ▶ Just 3 components that auto-detect on set up
- ▶ Discover a scalable solution that suits a variety of locations

Watch it here:
<http://paxton.info/3019>



Standalone Access Control

Standalone access control is the simplest way to secure and control access through doors around your building. If you're looking to step up security, protect your staff and assets and save money, then Standalone access control is for you.

- ▶ A non-networked access control solution
- ▶ Simple and unique card management system
- ▶ Internal (Compact)/external (Switch2)
- ▶ Suitable for small to medium sized premises, or any site looking to secure a small number of doors
- ▶ Entry and PaxLock Pro now work in standalone mode



Switch2

Switch2 is a standalone system that comes as a separate single door controller and reader. The door controller is fitted on the secure side of the door, with the reader fitted on the other side. Switch2 offers a secure solution for customers wishing to control door access, who do not need the reports on users' movements provided by a PC based access control system.

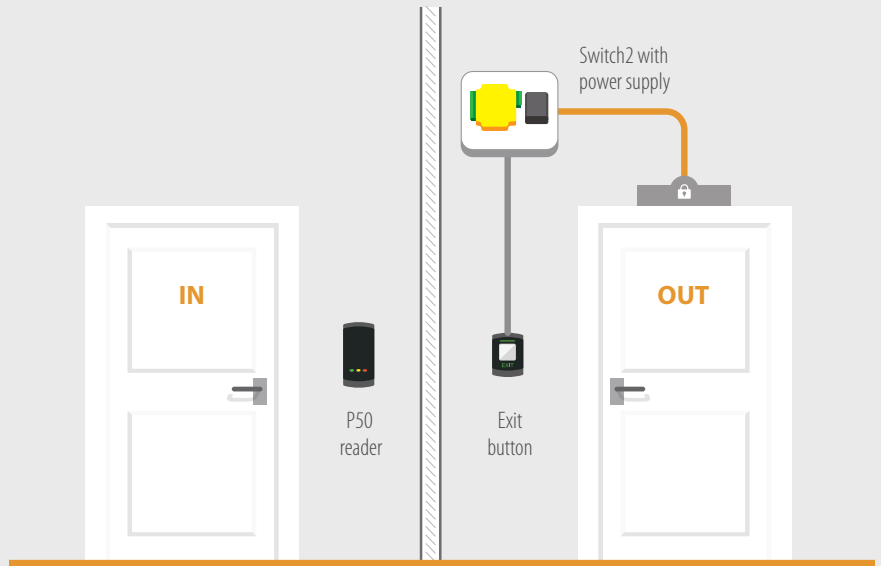

Switch2 controller

Sales code	Price
405-321	£90.00

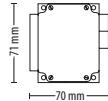

Switch2 controller -
12V 1A PSU, Plastic housing

Sales code	Price
242-166	£105.00

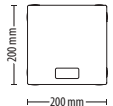

Entry

Our video door entry system now works in standalone mode for a quick, simple installation and easy user management with our standard enrolment and shadow cards. Offer a flexible system that can grow in line with your customers' requirements and be upgraded to work with Net2, with no hidden costs.

See page 32 for more information

PaxLock Pro

The latest addition to our range of wireless access control solutions, in a door handle can also be installed in standalone mode for use on sites not requiring the additional functionality of an online system. It's flexible upgrade path from standalone to networked creates a solution which can evolve with the needs of your customer. Internal and external versions are available in both black or white.

See page 6 for more information

Switch2 Readers

These readers are for use with Switch2. Designed to fit in seamlessly in any environment, our wide range means you get the right choice for your site requirements.



Proximity reader - P38

Sales code 333-110 Price £120.00



Proximity reader - P50 **BEST SELLER**

Sales code 353-110 Price £120.00

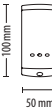

Proximity reader - P75

Sales code 373-110 Price £120.00

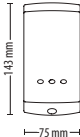

Proximity reader - P75, Screw connector

Sales code 373-120 Price £120.00

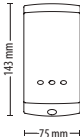

Proximity reader - P200

Sales code 323-110 Price £130.00

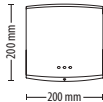

Proximity reader - P200, Metal mount

Sales code 324-110 Price £130.00

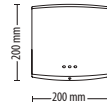

Proximity metal reader - Satin chrome

Sales code 390-747 Price £170.00

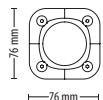

Proximity metal reader - Chrome

Sales code 390-727 Price £170.00

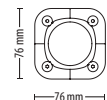



Proximity vandal proof reader

Sales code 568-855 Price £150.00

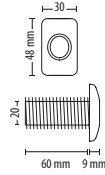

Proximity panel mount reader

Sales code 390-135 Price £150.00



Proximity marine reader

Sales code 500-010 Price £225.00

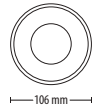

Proximity energy saving reader

Sales code 595-248 Price £125.00

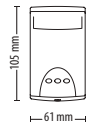

Proximity long range reader

Sales code 313-110 Price £285.00

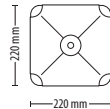

CARDLOCK reader - Satin chrome

Sales code 409-711SC Price £125.00

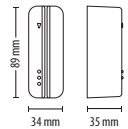

Proximity backbox reader - MIFARE®

Sales code 371-125 Price £160.00

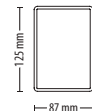

Proximity backbox reader - Black or white

Sales code 370-225BL/WT Price £150.00

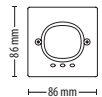

Proximity architectural reader - Matt black, Gunmetal grey or Satin chrome

Sales code 360-864BL/GG/SC Price £240.00



Insert - Stone

Sales code 361-002 Price £60.00



Insert - Glass with logo

Sales code 361-003 Price £60.00





TOUCHLOCK
vandal resistant metal keypad

Sales code 521-715 Price £130.00

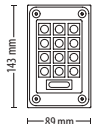

Proximity keypad - KP50

Sales code 355-110 Price £140.00

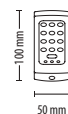

Proximity keypad - KP75

Sales code 375-110 Price £140.00

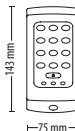

Proximity keypad - KP75, Screw connector

Sales code 375-120 Price £140.00

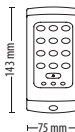

TOUCHLOCK
keypad - K50

Sales code 351-110 Price £45.00



TOUCHLOCK
keypad - K75

Sales code 371-110 Price £45.00

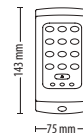

TOUCHLOCK
stainless steel keypad - K50

Sales code 352-110 Price £80.00

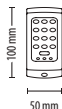

TOUCHLOCK
stainless steel keypad - K75

Sales code 372-110 Price £80.00

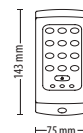

Compact

Compact is a standalone solution where all the electronics are housed within the reader. Compact is suitable for low security internal doors requiring a cost-effective solution.

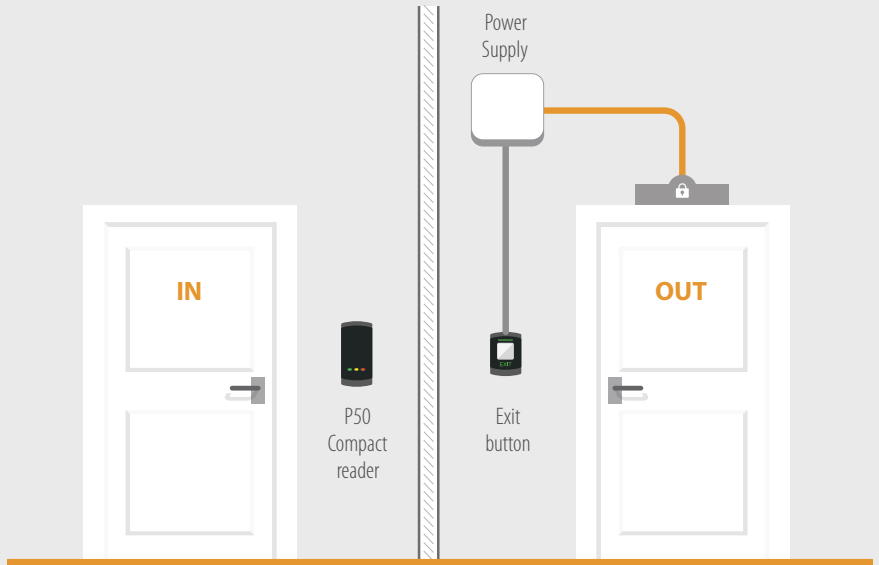

Compact proximity reader - P38

Sales code	Price
333-210	£145.00



Compact proximity reader - P50

Sales code	Price
353-210	£145.00

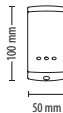

Compact proximity reader - P75

Sales code	Price
373-210	£145.00



Compact proximity vandal proof reader



Sales code	Price
326-735	£190.00

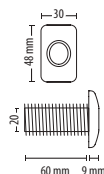



Compact TOUCHLOCK keypad - K50

Sales code Price
351-210 £70.00



Compact TOUCHLOCK keypad - K75

Sales code Price
371-210 £70.00

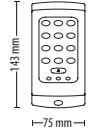

Compact TOUCHLOCK stainless steel keypad - K50

Sales code Price
352-210 £100.00

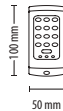

Compact TOUCHLOCK stainless steel keypad - K75

Sales code Price
372-210 £100.00

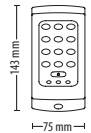

Compact vandal resistant metal keypad

Sales code Price
521-836 £135.00

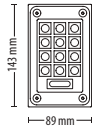

Standalone Access Control

Standalone Tokens

These tokens are for use with Switch2 and Compact systems..



Proximity 10 keyfob pack - Green, Amber or Red

Sales code	Price	BEST SELLER
820-010G/A/R	£70.00	

Proximity 50 keyfob pack - Green, Amber or Red

Sales code	Price
820-050G/A/R	£235.00



Proximity 10 card pack - Green, Amber or Red

Sales code	Price	BEST SELLER
830-010G/A/R	£70.00	

Proximity 50 card pack - Green, Amber or Red

Sales code	Price
830-050G/A/R	£235.00



CARDLOCK 1 extra user card - Amber

Sales code	Price
875-001A	£1.65



Proximity function card pack

Sales code	Price
820-000	£45.00



Switch2 hands free keyfob - Green, Pack of 10

Sales code	Price
860-010G	£350.00

Standalone Accessories

These accessories are for use with Switch2 and Compact systems.



Paxton exit button - E50

Sales code 356-310 Price £32.00



Paxton exit button - E75

Sales code 376-310 Price £32.00

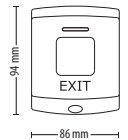

Paxton marine exit button

Sales code 593-721 Price £110.00



Paxton UK backbox adaptor - 75 series

Sales code 310-750 Price £6.50

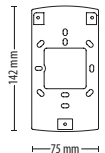

Paxton 12V 1A DC power supply - Plastic housing

Sales code 998-241 Price £35.00

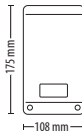

Proximity hands free interface - Plastic housing

Sales code 477-222 Price £110.00



Paxton 12V 2A DC power supply - Plastic cabinet

Sales code 857-250 Price £95.00

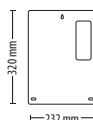

2A/12V DC power supply - no housing

Sales code 857-090 Price £75.00

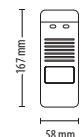

Standalone Access Control



Paxton reader cable -
10 core, CR9540, 100m reel

Sales code Price
166-100 £100.00



Compact relay module -
Pack of 5

Sales code Price
325-010 £28.00

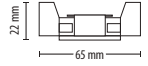

Paxton reader port connector -
Pack of 5

Sales code Price
325-030 £32.00

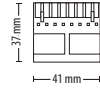

Proximity ISO card holder -
Clear, Pack of 5

Sales code Price
696-400 £5.00

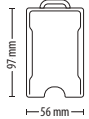

Proximity hands free card holders -
Suckers, Pack of 5

Sales code Price
696-100 £15.00

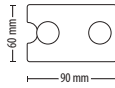

Free installer training

We offer practical training for installers for our complete range of networked, standalone and door entry products. Sessions are designed to provide you with the essential knowledge needed to install Paxton products quickly and efficiently.

- ▶ Ensure accurate installation
- ▶ Reduce time on site
- ▶ Courses are free of charge
- ▶ Materials and equipment provided

For more information and to book a session, go to <http://paxton.info/1940>.

End-user training is also available; for more information and pricing, contact training@paxton.co.uk.



Industry leading technical support

Call Paxton and you will be put straight through to our expert support team, based at Paxton House. Our friendly team are available from 7am-7pm Monday-Friday, and 9am-1pm on Saturdays.

Call : 01273 811011
 E-mail : support@paxton.co.uk
 Skype : paxton.support



Sales literature

We offer an extensive range of brochures and sales guides to support you every step of the way, from sales to specification. All documentation is available to download from our website at <http://paxton.info/474>.

Case studies

Find out how the Net2 system can be adapted to meet a range of diverse requirements by reading our latest case studies. We have a range of examples covering education, healthcare, retail, leisure, commercial and public buildings.

See our latest case studies here:
<http://paxton.info/3016>

Net2 Integration

As UK market leaders in access control, Paxton want to ensure that we are providing the most sophisticated solutions available. We do this by working with quality manufacturers to provide the best of breed solutions and making them available to you. You can see a map of our Net2 integration partners at <http://paxton.info/2487>.



Newsletter sign up

The Paxton Installer is your monthly newsletter, containing the latest news, product information and updates from us. Every month your copy of the Paxton Installer will arrive in your inbox - full of useful information that will make your job easier and help you to win more business.

Sign up now:
<http://paxton.info/3020>

Paxton 5 Year Guarantee and Hassle Free Returns Policy

We offer a five year guarantee on all our products*. If a problem arises, follow these three simple steps and we will get your return sorted:

1. Call into Support if a problem arises on site, Support will then troubleshoot the issue.
2. If the issue cannot be solved, you will be supplied with a returns number.
3. Within 30 days you can either:
 - a. Send the product directly to Paxton with the returns number for an exchange
 - b. Return to your distributor for an exchange



*Unless otherwise stated

Distributors - Where to Buy

Our UK distributors are listed below. We regularly review their stock and make sure that it is up-to-date, correctly stored and free from defects. To ensure the quality of your Paxton system, we advise that you purchase only through a franchised distributor.

 <p>ADI GLOBAL DISTRIBUTION</p> <p>ADI Global Distribution 0161 767 2900 www.adiglobal.com/uk</p>	 <p>Advanced Access</p> <p>Advanced Access Ltd 01604 647555 www.advanced-access.co.uk</p>	 <p>Alarm Supplies</p> <p>Alarm Supplies 0141 353 1354 www.alarm-supplies.com</p>	 <p>Aldridge Masters of Security Distribution</p> <p>Aldridge Security Ltd 08444 125101 www.aldridgesecurity.co.uk</p>
 <p>ENTERPRISE SECURITY DISTRIBUTION</p> <p>Enterprise Security 0207 732 3826 www.enterprisesecuritydistribution.com</p>	 <p>EUROCABLES Belfast</p> <p>Eurocables Belfast Ltd 02890 777771 www.eurocables.co.uk</p>	 <p>MAYFLEX A Sonepar Company</p> <p>Mayflex UK Ltd 0800 881 5199 www.mayflex.com</p>	 <p>NORBAIN</p> <p>Norbain SD Ltd North: 01253 894488 South: 0118 9125000 www.norbain.co.uk</p>
 <p>OPREMA</p> <p>Oprema Ltd 029 2064 1509 www.oprema.co.uk</p>	 <p>security supplies</p> <p>Security Supplies Ltd 01489 563 400 www.security-supplies.co.uk</p>		



Product Selection Guide 2020

Paxton Access Ltd

Paxton House
Home Farm Road
Brighton
East Sussex
BN1 9HU
UK

 01273 811011

 support@paxton.co.uk

 www.paxton-access.com

The Bluetooth® word mark and logos are registered trademarks owned by the Bluetooth SIG, Inc. and any use of such marks by Paxton Access Ltd. is under license.

MIFARE® is a registered trademark of NXP B.V. and is used under license.

The Genuine HID Technology logo is a trademark of HID Global Corporation/ASSA ABLOY AB. Used with permission.

All information and specifications correct at the point of publication, but may be subject to change without notice.